

*“ Ustaların Malzemesi,  
Malzemenin Ustası ”*

**2021  
PRODUCT  
CATALOG**

**CUKUROVA**<sup>®</sup>  
polistren dekor

[www.cukurovapolistren.com.tr](http://www.cukurovapolistren.com.tr)

Çukurova Polistren, Hazır Kartonpiyer, EPS Tavan Plakası, Lamba Göbekleri, Desenli Kartonpiyer, Dış Cephe Söve, Denizlik, Fuga, Sütun, Kaide, Payanda vb. dekorasyon ürünlerinin yanı sıra; Mantolama Board, Asmolen ürünleri ile de izolasyon grubuna hitap etmektedir.

Değişen dünya düzeni ve ekonomik değişiklikleri çok iyi okuyarak, satış ve yatırım stratejileri belirledik . Bunları özenle uyguladık.

İhracatta bölgemizde ve sektörümüzde sayılı firmalardan biri olarak ve buna bağlı artan istihdamımızla ülke ekonomisine fayda sağladık, sağlıyoruz, sağlayacağız...

Hem sermayemizi hem de piyasada ki yerimizi koruduk. Bu istikrarlı yönetim anlayışımız bize 'güven' ve 'büyüme' olarak geri döndü. Yılı kayıpsız bitirmenin ve hedeflerimize ulaşmanın haklı gururu içerisindeyiz.

## İHRACAT

Firmamız ihracat hedeflerine bir bir ulaşmaktadır. Ortadoğu pazarında birçok ülkede markamız yayılmaktadır. Dünyanın en prestijli fuarlarına katılarak Afrika ve Asya'da ki pazarımızı genişletmeye çalışıyoruz.

## KALİTE POLİTİKASI

Sağladığımız ürün ve hizmetlerde; müşteri memnuniyetini en üst düzeyde tutmak, müşteri geri bildirimlerini etkin bir şekilde yönetmek, değer yaratmayan işlemleri ortadan kaldırarak kaynakların etkin kullanımı ile zamanında teslimat yapmak ve sürekli iyileştirmeyi amaçlayan bir kalite yönetim sistemi oluşturmaktır. Bu doğrultuda ISO9001, ISO14001 ve ISO18001 belgelerini alıyoruz.

Çukurova Polistren müşterilerinin işlevsel gereksinimlerini en ekonomik ve teknik olanaklarla bağdaştırarak estetik ve modern projeler meydana getirir. Ürettiği projelerinde müşterilerinin hayallerini temel alarak güncel gelişmeleri çalışmalarına adapte ederek konforlu yaşam alanları tasarlar ve uygular ve projelerinde konfor, sağlamlık ve güzelliği ön planda tutmaktadır.

2012

### KURULDU

2000m<sup>2</sup>'lik tesisinde üretime başladı.



2013

### BÜYÜDÜ

Hızlıca piyasada sevilen bir marka haline geldi ve mevcut üretim tesisini genişletme kararı aldı ve üretim tesisini 7000m<sup>2</sup>'lik kapalı alana taşıyarak üretim kapasitesini kat ve kat arttırdı.



2013

2014

### BÜYÜMEYE DEVAM EDİYORUZ...

Şu anda 10.000m<sup>2</sup>'lik alanda üretime devam etmektedir.



### YENİDEN YAPILANMA

Haziran ayında elim bir kaza sonucu fabrikamızın bir kısmını yangında kaybettik. Güçlü ekibimiz ve birbirimize olan inancımızla çok kısa sürede toparlanarak 10 gün içerisinde O.S.B'de yeni bir fabrika ile üretime yeniden başladık.

2015  
HAZİRAN

2019

Değişen Ticari koşulları lehimize çevirerek verimli bir yıl geçirdik. Yeni fabrikamız için yer alımını yapıp projelere başladık.



GÜÇLENEREK  
DEVAM EDİYORUZ...



## İŞ GÜCÜ

Çukurova Polistren'de herkes kendi işinin lideridir; esnek organizasyon yapımız her çalışanın kendi işiyle ilgili konularda sorumluluk almasına ve inisiyatif kullanmasına olanak tanır. Çukurova Polistren toplamda 60 üretim çalışanı ve 15 idari personel ile hizmet vermektedir.

## FİYAT POLİTİKASI

Bölgemizde faaliyet gösteren inşaat Firmaları ve müteahhitlerin en çok tercih ettiği çalışma ve iş ortaklarından olan Çukurova Polistren; sağladığı kaliteli ürün ve hizmet anlayışının yanısıra uygulamış olduğu uygun fiyat politikasıyla da ayrıca bireysel tüketicilere de özel imkankar sunmaktadır. Toptan fiyatına perakende fiyattan satış yapan Çukurova Polistren böylece ev yaptıran ve yapmayı düşünenlerin bütçelerine ayrıca bir katkı sağlamaktadır.

*%98 EPS to be precise.*

*Nothing insulates better than air!*

### **WHAT IS EPS?**

EPS with the technical term Expanded Polystyrene, is a lightweight, rigid, plastic foam insulation material produced from solid beads of polystyrene. Expansion is achieved in a steamed process to form a perfectly closed cellular structure. These cells occupy approximately 40 times the volume of the original polystyrene bead. In a next step the material is moulded into appropriate forms suited to their application. EPS is 98% air, engineered air, the plastic material encapsulating the air, harnessing its benefit as an excellent insulation and shock absorption material.

- Comfort Cover
- Trouble shooter
- Protective
- Money saver
- Green

## İÇ CEPHE INTERIOR

● <b>KARTONPİYER</b> <i>Papier Mache</i>	<b>4-8</b>	● <b>İÇ CEPHE MOTİF</b> <i>Interior Wall Motif</i>	<b>16-17</b>
● <b>PERDELİK</b> <i>Papier Mache</i>	<b>8</b>	● <b>EPS KARTONPİYER</b> <i>EPS Papier Mache</i>	<b>18-20</b>
● <b>ÇITA</b> <i>Laths</i>	<b>9</b>	● <b>ÇITA KÖŞESİ - DESENLİ ÇITA</b> <i>Interior Lath</i>	<b>21</b>
● <b>IŞIK BANDI</b> <i>Light Strip</i>	<b>10-11</b>	● <b>LAMBA GÖBEĞİ</b> <i>Ceiling Navel</i>	<b>22-23</b>
● <b>IŞIKLI ASMA TAVAN</b> <i>Lighting Suspended Ceiling</i>	<b>12-13</b>	● <b>TAVAN KAPLAMA</b> <i>Roof Covering</i>	<b>24</b>
● <b>TV ÜNİTELERİ</b> <i>TV Units</i>	<b>14</b>	● <b>DEKORATİF KİRİŞ</b> <i>Decorative Beam</i>	<b>25</b>
		● <b>DEKORATİF PAYANDA</b> <i>Decorative Buttress</i>	<b>26</b>

## DIŞ CEPHE EXTERIOR

● <b>SÖVE</b> <i>Door&amp;Window Frame</i>	<b>29-34</b>	● <b>BALASTROT</b> <i>Balastrot</i>	<b>56</b>
● <b>DEKORATİF SÖVE</b> <i>Exterior Decorative Beam</i>	<b>34</b>	● <b>PAYANDA</b> <i>Buttress</i>	<b>57-58</b>
● <b>TAÇ</b> <i>Crown</i>	<b>35-36</b>	● <b>KİLİT TAŞI</b> <i>Keystone</i>	<b>59-60</b>
● <b>TAÇ DEKOR</b> <i>Crown Decor</i>	<b>37-38</b>	● <b>ROZET</b> <i>Rosette</i>	<b>61</b>
● <b>DENİZLİK</b> <i>Window Sills</i>	<b>39-40</b>	● <b>MOTİF</b> <i>Motif</i>	<b>62-64</b>
● <b>KAT SİLMESİ</b> <i>Floor Stringer</i>	<b>41-44</b>	● <b>FUGA</b> <i>Fair Coating</i>	<b>66-68</b>
● <b>HARPUŞTA - MANTOLAMA ÇITASI</b> <b>YUVARLAK PENCERE</b> <i>Cover Fance - Insulator Bauliban- Window Corner Decor</i>	<b>45</b>	● <b>TUĞLA FUGA</b> <b>YALI BASKI</b> <i>Brick Figured Coating - Shore Siding</i>	<b>69</b>
● <b>ÇITA</b> <i>Lath</i>	<b>46</b>	● <b>ENJ. FUGA</b> <i>Injection Fair Coating</i>	<b>70</b>
● <b>KÖŞE ELEMANLARI</b> <i>Corner Elements</i>	<b>47</b>	● <b>YRD. ÜRÜNLER-YAPIŞTIRICILAR</b> <i>Adhesive</i>	<b>71</b>
● <b>ENJ. KÖŞE ELEMANLARI</b> <i>Injection Corner Elements</i>	<b>48</b>	● <b>MANTOLAMA</b> <i>Insulation</i>	<b>72</b>
● <b>BORU KAPLAMA - KOLON</b> <i>Pipe Closing / Column</i>	<b>49</b>	● <b>HAMMADDE</b> <i>Raw Materials</i>	<b>73</b>
● <b>SÜTUN VE KAİDE</b> <i>Column and Base</i>	<b>50-55</b>	● <b>ÖRNEK PENCERE MODELLERİ</b> <i>Sample Window Models</i>	<b>74-75</b>



**Yüksek dansite EPS ve XPS ürünlerin  
şekillendirilmesiyle elde edilir.**

**All the products are obtained with  
high density EPS and XPS.**

**كل المنتجات تصنع من مادة البوليسترين هي ذو كثافة عالية**

### Özellikler

1. Ürünlerin standart boyu 200 cm. dir
2. Beyaz renkli olup B1 sınıfı alev yürümez malzemedir.
3. Montajı kolaydır.
4. Uzun ömürlüdür.
5. İstenilen renk su bazlı boya ile elde edilebilir.
6. Yalıtım sağlar.
7. İnsan sağlığı için zararsızdır.
8. İstenilen model ve ölçüde üretilebilir.

### Properties

1. Standard length: 200 cm.
2. Color: white Classification B1 unflammable products.
3. Simple assembly,
4. Life-time warranty
5. Different colors are available upon a request.
6. Crucial role of thermal insulation
7. No harm to human health
8. Different models and sizes are available upon a request

### الخصائص:

1. الطول القياسي ٢٠٠ سم
2. ذات لون ابيض تصنيفها... وهي مادة غير قابلة للاشتعال و الذوبان
3. سهولة التركيب
4. عمرها طويل
5. متوفرة بالوان متعددة حسب الطلب
6. لها قابلية للعزل
7. غير مضره بصحة الانسان. صديقة للبيئة
8. متوفرة باشكال و احجام مختلفة حسب الطلب

CKP 01

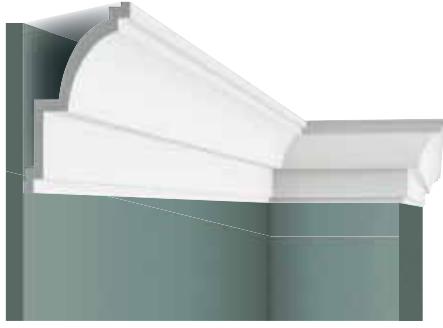
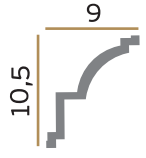

CKP 10

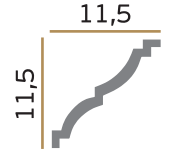

CKP 06

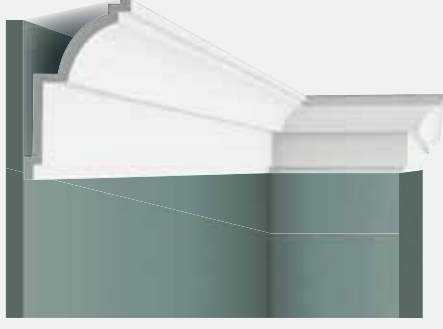
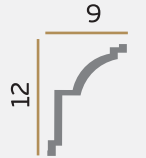

CKP 11

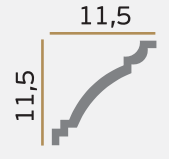

CKP 07

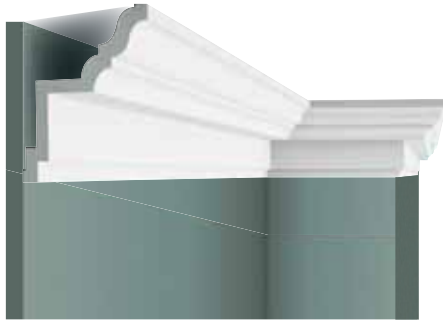
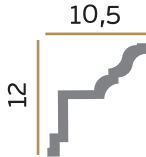

CKP 12

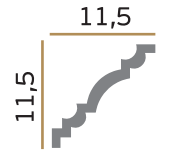

CKP 08

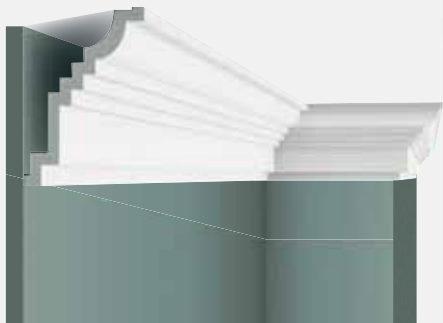
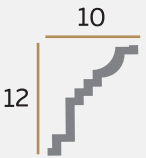

CKP 13

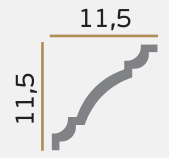

CKP 09

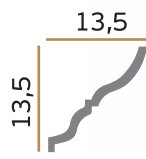

**CUKUROVA®**  
 Fix|polistren dekor

 Tecrübeli ustaların tercihi,  
 tecrübe ile üretilmiş  
**kartonpiyer yapıştırıcısı**  
**CYRD 10**

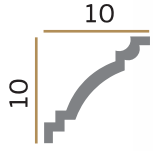

CKP 14

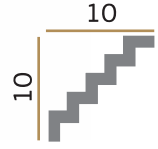

CKP 19

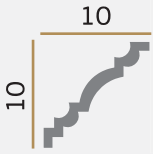

CKP 15



CKP 20

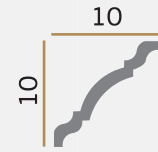

CKP 16

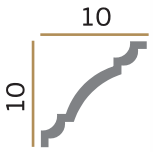

CKP 21

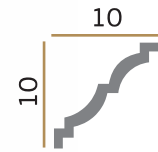

CKP 17

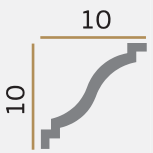

CKP 22

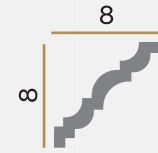

CKP 18

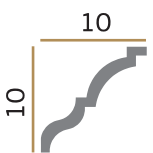

CKP 23

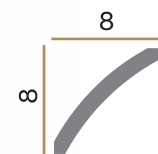

CKP 24

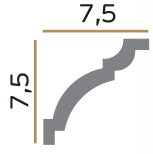

CKP 29

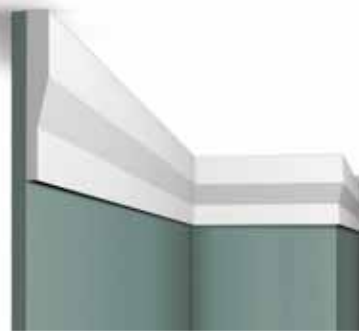

CKP 25

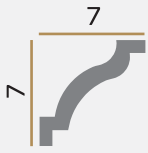

CKP 35

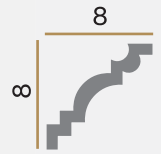

CKP 26

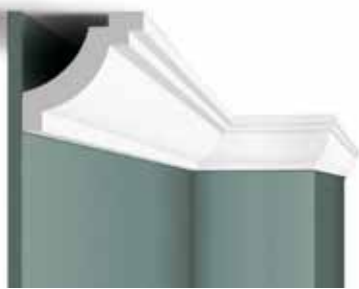
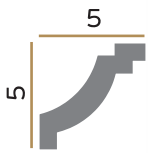

CKP 36

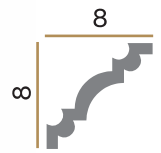

CKP 27

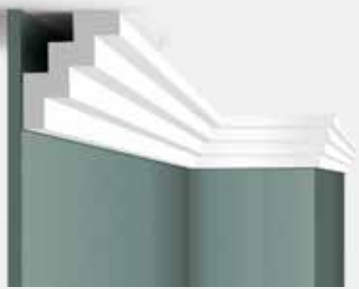
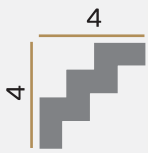

CKP 37



CKP 28

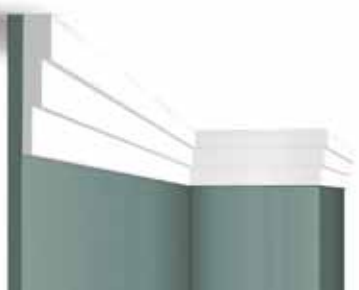

CKP 38

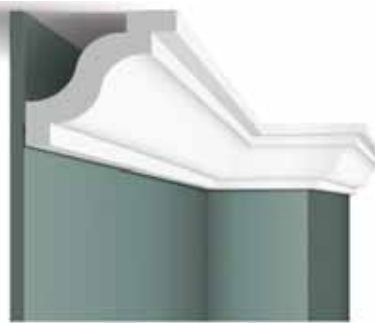
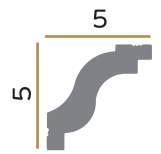

CKP 39

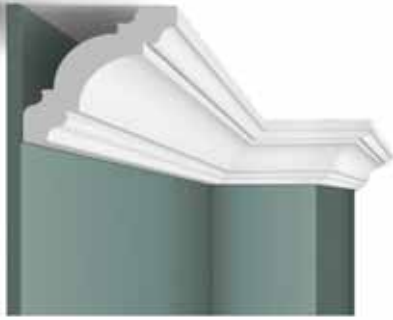
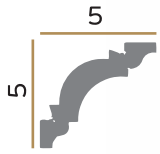

CKP 46

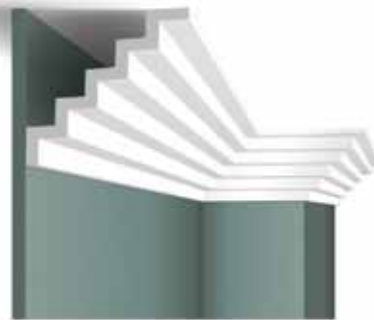
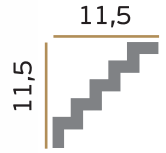

CKP 40

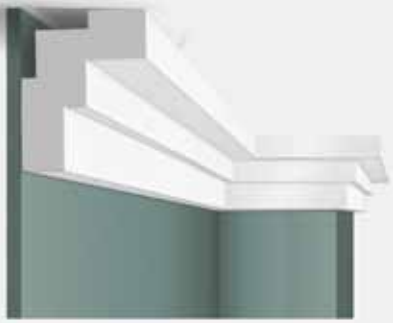
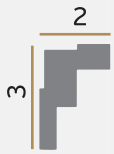

CKP 47

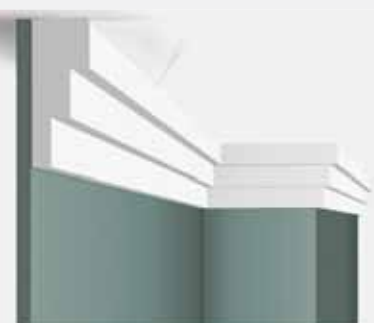

CKP 41

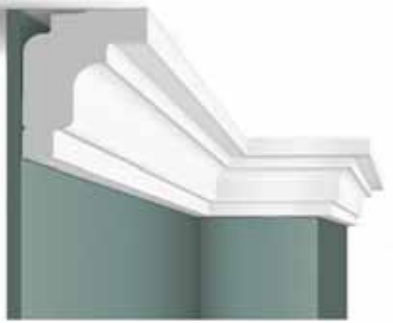

CKP 48

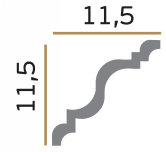

CKP 42

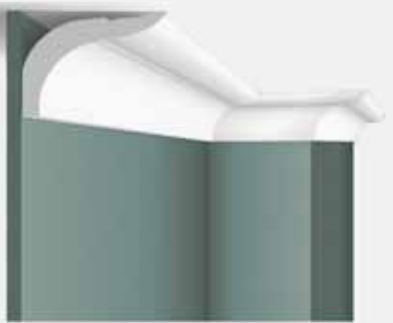
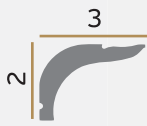

CKP 49

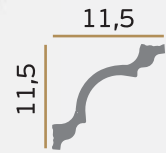

CKP 45

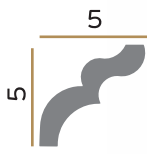

CKP 50

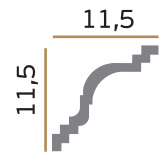



Kartonpiyer

CKP 51

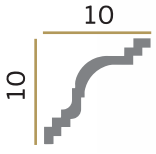

CKP 56



CKP 52

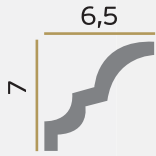

CKP 57

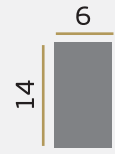

CKP 53

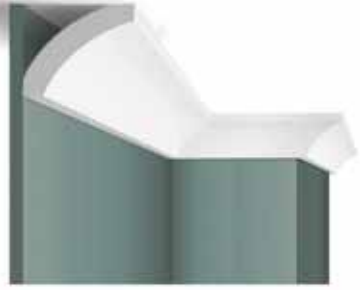
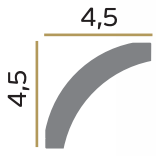

CKP 58



CKP 55



CKP 59



Perdelik

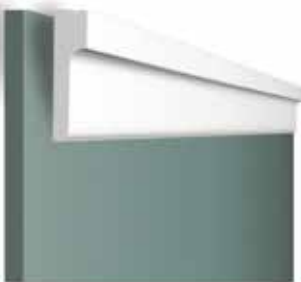

CPT 08



CPT 10



CPT 12



CKP 30



CKP 32

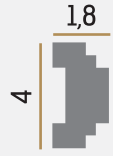

CKP 31



CKP 33



CKP 60



CKP 61



CIB 02



CIB 08

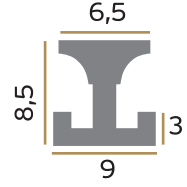

CIB 03



CIB 09



CIB 04

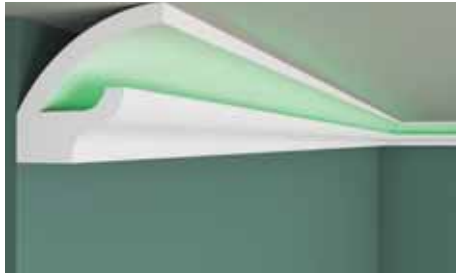
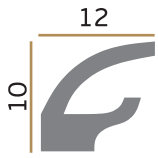

CIB 10

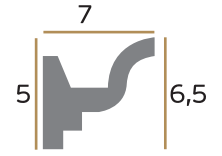

CIB 05

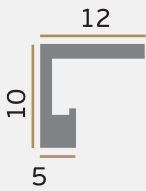

CIB 11



CIB 07

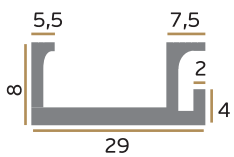

CIB 12



CIB 13



CIB 18



ÇİM'ler için taşıyıcı olarak kullanılmaktadır.

CIB 15

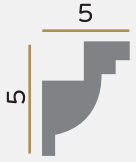

CIB 19



ÇİM'ler için taşıyıcı olarak kullanılmaktadır.

CIB 16

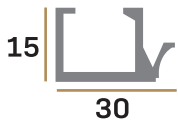

CIB 20

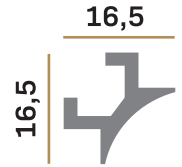

CIB 17

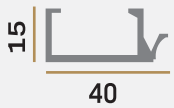

CIB 21

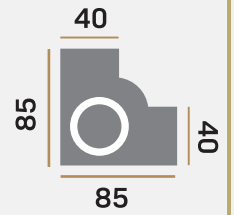

## POLİSTREN IŞIK BANDIYLA

hem işçilikten tasarruf edin, hem de binanızı hafifletin.  
Ürünlerimiz alev yürütmez hammaddeden üretilmektedir.

CAT 01

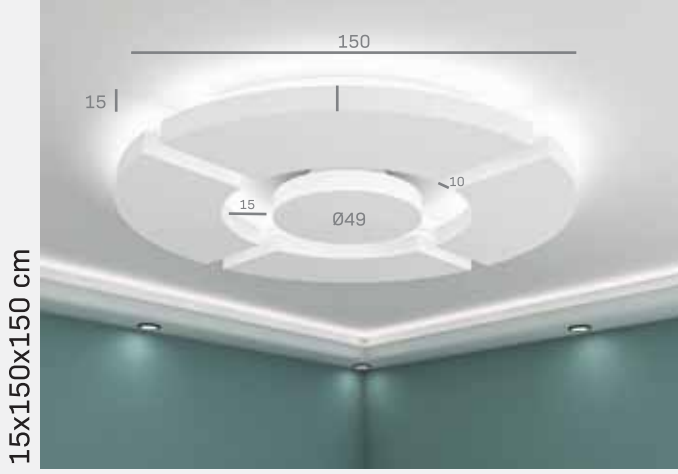

CAT 03



CAT 02



CAT 04

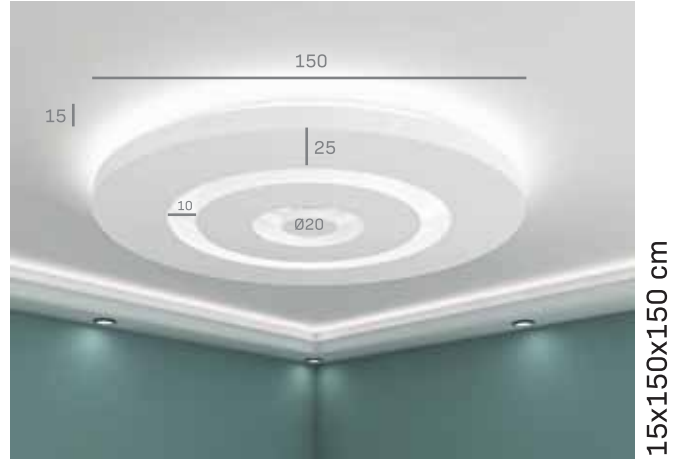

ÜRÜNLERİMİZ **YÜKSEK YOĞUNLUKTA XPS**



CAT 05



CAT 07



CAT 06



CAT 08



**HAMMADEDEN ÜRETİLMEKTEDİR!**

CTV 01

15x210x230 cm



CTV 04

15x200x250 cm



CTV 02

15x200x270 cm

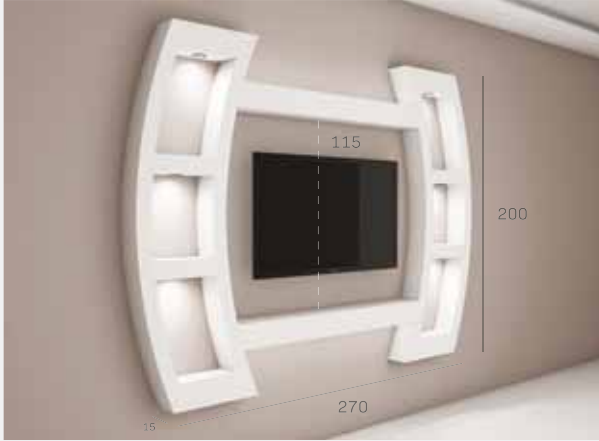

CTV 05

15x200x250 cm

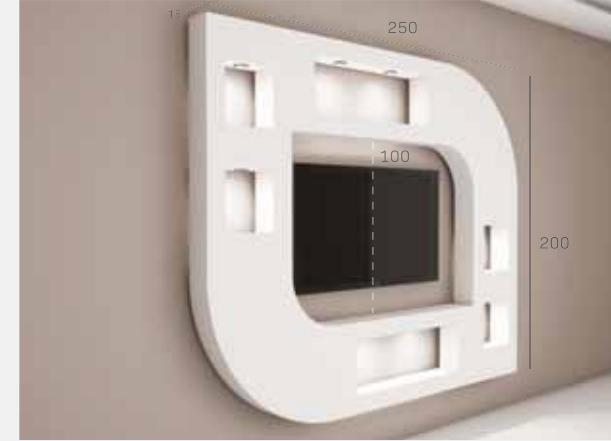

CTV 03

15x230x260 cm



CTV 06

15x200x220 cm

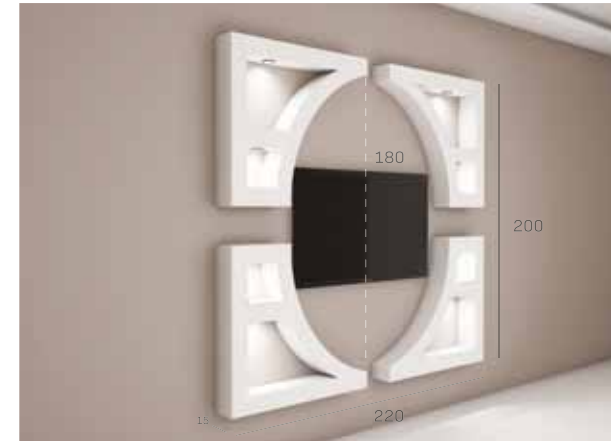

*Yaşamınızı*

*Güzelleştiren*

*Detaylar...*

CİM 01

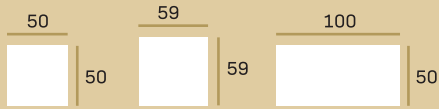

CİM 03

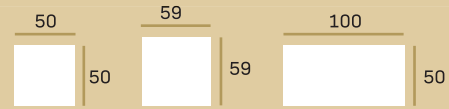
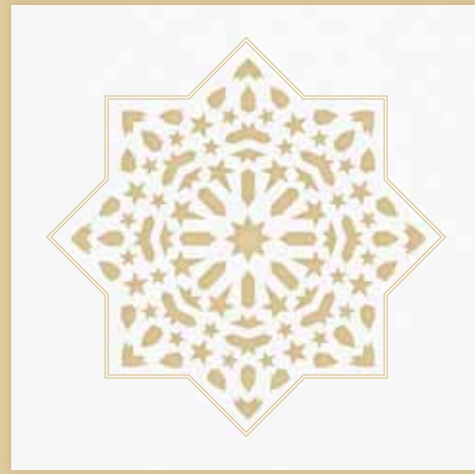

CİM 02

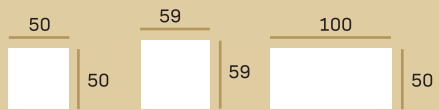

CİM 04

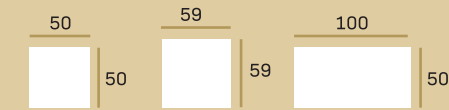



CİM 05



2x50x100 cm

CİM 08



2x50x100 cm

CİM 06

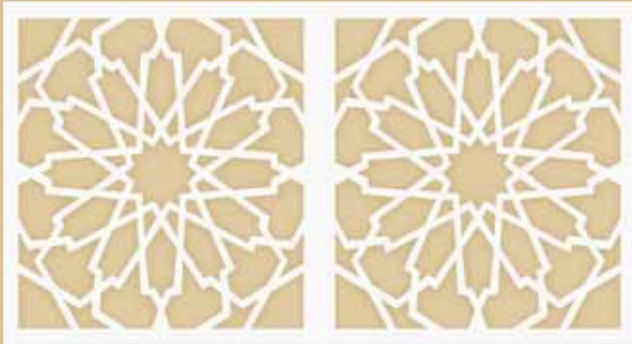

2x50x100 cm

CİM 09



2x50x100 cm

CİM 07

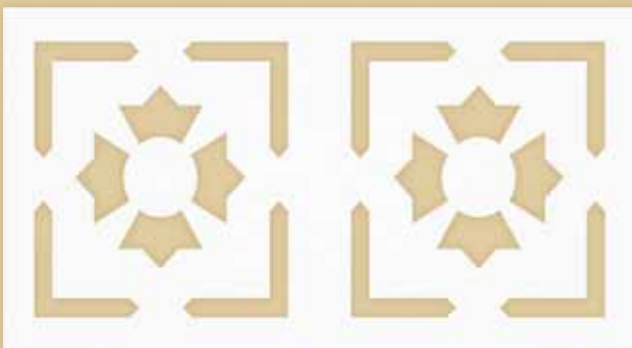

2x50x100 cm

CİM 10

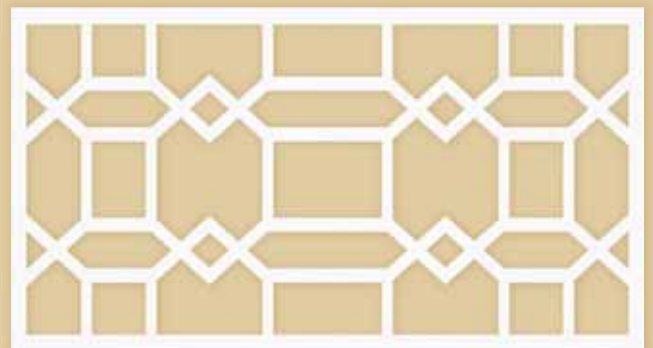

2x50x100 cm



**CEDK 02**

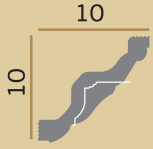

**CEDK 03**



**CEDK 06**



**CEDK 10**



**CEDK 11**

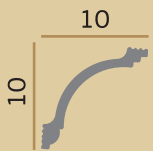

**CEDK 12**

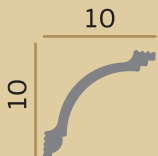

CEDK 13

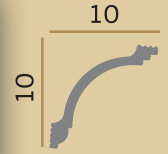

CEDK 14

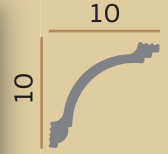

CEDK 17

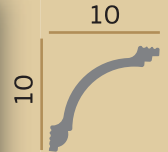

CEDK 18



CEDK 19



CEDK 21



**CEDK 22**

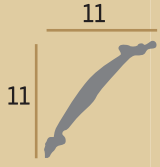

**CEDK 23**

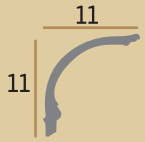

**CEDK 24**



**CEDK 25**

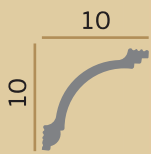

**CEDK 27**



**CEDK 28**

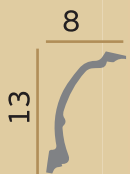

CKP 31



CKP 33



CKP 31



CDÇ 01



CDÇ 02



ÇÇK 01

ÇÇK 02

ÇÇK 03

ÇÇK 05

ÇÇK 06

ÇÇK 04



**CYRD 10**

Tecrübeli ustaların tercihi, tecrübe ile üretilmiş  
iç cephe yapıştırıcısı



CDÇ 04



CDÇ 03





CGB 01



Ø39

Ø47

Ø55

CGB 04



Ø39

Ø47

CGB 02



Ø39

Ø47

CGB 05



Ø39

Ø47

CGB 03



Ø39

Ø47





CGB 07



Ø47  
Ø55  
Ø70

CGB 10



Ø70

CGB 08



Ø55

CGB 11



Ø55

CGB 09



Ø70

CGB 12



Ø70

CTK 02



50x50

CTK 08



50x50

CTK 03

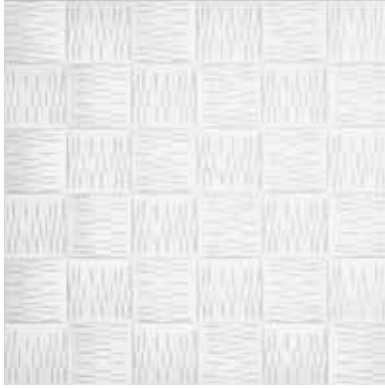

50x50

CTK 09



50x50

CTK 05



50x50

CTK 10



50x50

CTK 07



50x50

CTK 11



50x50

CDK 01

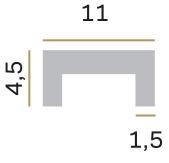

CDK 07

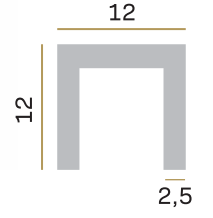

CDK 02

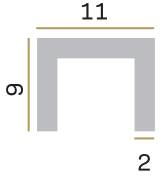

CDK 08

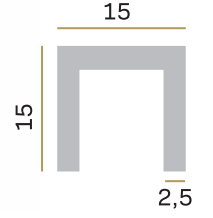

CDK 03

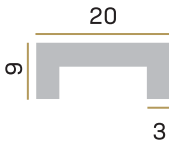

CDK 09

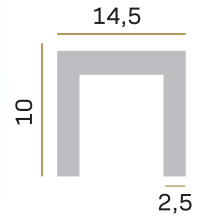

CDK 04

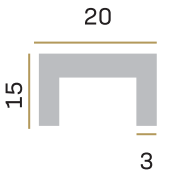

CDK 10

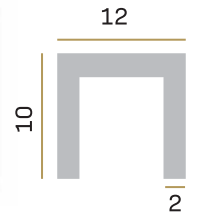

CDK 05

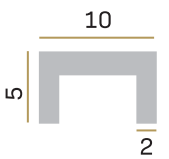

CDK 11

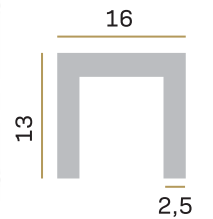

CDK 06

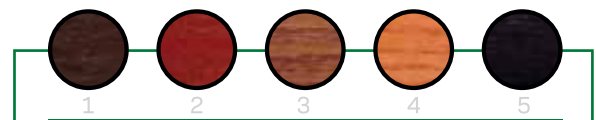
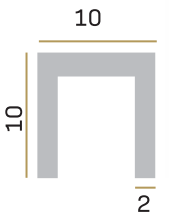

İstenilen ahşap renginde sipariş edilebilir.



CDP01

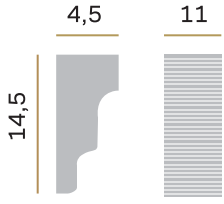

CDP02

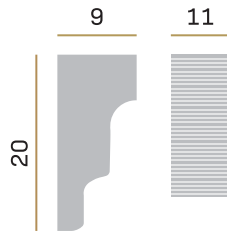

CDP03

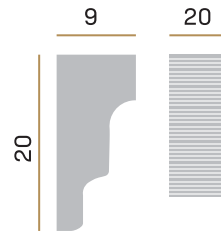

CDP04

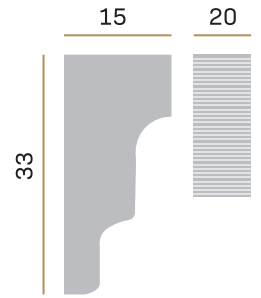

CDP05

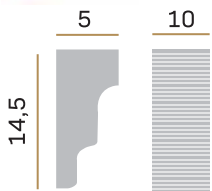

CDP06

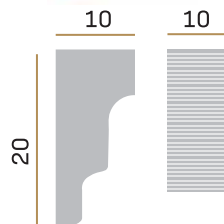

CDP07

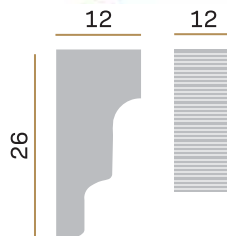

CDP08

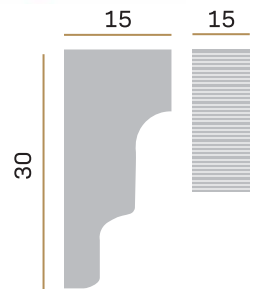



## EPS'İN TANIMI

Expanded Polisten Sert Köpük (EPS-Genleştirilmiş Polisten Sert Köpük), petrolden elde edilen, köpük halindeki, termoplastik, kapalı gözenekli, tipik olarak beyaz renkli bir ısı yalıtım malzemesidir.

Polisten taneciklerinin şişirilmesi ve birbirine kaynaşması ile elde edilen EPS (Genleştirilmiş Polisten Sert Köpük) ürünlerde, taneciklerin şişirilmesi ve köpük elde edilmesi için kullanılan şişirici gaz Pentan'dır. Pentan, tanecikler içinde çok sayıda küçük gözeneklerin oluşmasını sağladıktan sonra, üretim sırasında ve üretimi takiben çok kısa sürede hava ile yer değiştirir. Böylece EPS levhaların bünyesinde bulunan çok sayıda (1 m<sup>3</sup> EPS' de milyar) küçük kapalı gözenekli hücreler içinde durgun hava hapsolür. Malzemenin %98'i hareketsiz ve kuru havadır.

Üretimimin enerji yoğun olmaması, üstün teknik özelliklerine rağmen ekonomik olmasının diğer önemli sebebidir. Etkin mekanik dayanımın yanında şişirici gazın çok kısa sürede hava ile yer değiştirmesi, ürünün performansının kullanım ömrü boyunca sabit kalmasını sağlar. Kalınlığı incelmaz, ısı iletkenliği artmaz, özelliklerinde hiçbir bozulma meydana gelmez.

EPS üretiminde son aşama olan şekil verme (kalıplama) aşamasında, taneciklerin birbirleri ile sıkıca kaynaşması sağlanır. Bu uygulamanın başarısı, ürünün yüzeyindeki taneciklerin bal peteği şeklindeki görüntüsünden anlaşılır.

## KULLANIM YERLERİ

Yapıların yan duvar, teras çatı, zemin ve bodrumlarının sıcağa-soğuğa karşı yalıtımında, hafif prefabrik yapı elemanlarında, soğutma tesislerinde ticari depolarda, dilatasyon ve yağmur derelerinde, cam ve kırılabilir ürün taşımacılığında ambalajlamada balıkçılık sektöründe kalıp olarak kullanımı reklamcılık ve dekorasyon sektöründe ekspanda polisten köpük yaygın olarak kullanılmaktadır.

## DESCRIPTION OF EPS

Expanded Polystyrene Hard Foam is a kind of insulation material from petrol that is in the form of foam, thermoplastic, that has closed pore and typically white color.

In the EPS (Expanded Polystyrene Hard Foam) product which is obtained with blowing up polystyrene particles and then combination of these them, the gas used to blow up particles and obtain foam is "pentane": After providing formation of many small pores within particles, pentane replaces with air in a short period of time during the time of production and following the production. Thus, EPS is confined to stagnant air within the numbers (3.6 billion in 1 m<sup>3</sup> EPS) of very small closed porous cells in EPS plates. 98% of the material is still and dry air.

It is one of the other important reasons to be economic, despite its high technical specification, because production is not energy intensive. Replacement of blowing gas with air in a very short period of time as well as active mechanical resistance provides the performance of product to be stable during the use life. Its thickness does not becomes thin. its thermal conductivity does not increase and no deformation occurs in its specifications.

In the stage of shaping (moulding) that's the last stage in EPS production, tightly combination of particles is provided. Achievement of that application is seen through the honeycomb appearance of particles on the product surface.

## PLACES OF USE

Expanded polystyrene foam is commonly used for the insulation of constructions' side walls, terrace penthouses, ground floor and cellars against heat-cold, in the light prefabricated constructional elements, cooling facilities, commercial warehouses, dilatation and rain streams, transportation of glass and breakable product, packing, in the fishing sector as mould an advertising and decoration sector.



### تعريف البوليسترين

رغوة البوليسترين بين القاسية المتمددة الذي نحصل عليه من البترول بشكل رغوة و تكون لدنة و ذو لون ابيض التي تشكل بدورها احد مواد العزل الحراري.

ان انتفاخ حبات البوليسترين و تمازجها و اندماج الحبات مع بعضها ينتج لدينا منتج البوليسترين و لإتمام تمازج و اندماج و انتفاخ حبات البوليسترين مع بعضها البعض يتم استعمال غاز البنتان. بعد حدوث ثقب صغيرة في الحبات بفعل البنتان و اثناء تعقيب الانتاج في زمن قصير جدا تقوم بتغيير مكانها مع الهواء. وهكذا يتواجد في 1 م<sup>3</sup> من لوحة البوليسترين حوالي مليار ثقب مغلق صغير.

ويتم حبس الهواء داخلها و 98% من المواد تكون هواء جاف و ثابتة, وبسبب عدم كثافة طاقة الانتاج و وجود الخصائص التقنية تكون ذو تكلفة اقتصادية التي بدورها تسبب اهمية المنتج.

الى جانب فعالية ثباتها فان الغاز المسبب للانتفاخ تغير مكانها مع الهواء وفعالية استعمال المنتج تكون ثابتة مدى الحياة و لا يتم قلة سماكتها و لا تقوم ايضا بزيادة النقل الحراري و لا تتسبب بتخريب اي خاصية من خصائصها. اثناء انتاج اللوح البوليسترين في مرحلته الاخيرة يتم اعطاء الشكل النهائي للقلب و تضمن بذلك تمازج الحبات و تماسكها و نجاح هذه العملية يتضح من شكل توضع الحبات الذي يكون على شكل خلايا المنحل.

### امكان استخدامها:

الجدان الجانبية للمباني, تراس سطوح المباني, المداخل والمستودعات, عوازل للحرارة و للبرودة, في المباني مسبقة الصنع الخفيفة منشآت التبريد, المستودعات التجارية, المجاري المائية, الزجاج, املاج المواد القابلة للكسر, قطاع الاسماك يتم استخدامه كغالب, و لأغراض الدعاية و الاعلان والديكور خاصة تكون منتشرة بشكل كبير.

*Yüksek dansite EPS ürünlerin şekillendirilmesiyle elde edilen polistrene, birden çok kimyasal maddenin karıştırılmasıyla oluşan akrilik esaslı reçinenin kaplanmasıyla elde edilir.*

*All the products are obtained with shaping high density EPS with covering of acrylic compounds.*

**كل المنتجات مصنعة من البوليسترين هي ذو كثافة عالية مع خليط من مواد كيميائية متعددة كالاكرليك**

## Özellikler

1. Ürünlerin standart boyu 200 cm. dir.
2. Kaplama malzemesinin kalınlığı her yerde aynı olup polistrenden ayrılmaz.
3. Esnek bir yapısı vardır, darbeye dayanıklıdır.
4. Statik açıdan hafiftir, binaya yük getirmez.
5. İstenilen renk boya ile elde edilebilir.
6. Yalıtım sağlar.
7. İnsan sağlığı için zararsızdır.
8. İstenilen model ve ölçüde üretilebilir.
9. Uzun ömürlüdür

## Properties

1. Standard length: 200 cm.
2. The thickness of the coating is same everywhere and do not separate from the Polystyrene.
3. Flexible and resistance to cracks.
4. It is light, does not add load to the building.
5. Different colors are available upon a request.
6. Crucial role of thermal insulation.
7. No harm to human health.
8. Different models and sizes are available upon a request.
9. Life-time warranty

## الخصائص:

1. الطول القياسي ٢٠٠ سم
2. سماكة مادة الغطاء نفسها في كل مقاطع البوليسترين
3. مطاوعة ولها مقاومة ضد الكسر
4. ذات وزن خفيف و بالتالي لا تضيف احمال زائدة على المبنى
5. متوفرة بالوان متعددة حسب الطلب
6. لها قابلية للعزل
7. غير مضره بصحة الانسان
8. متوفرة باشكال واحجام مختلفة حسب الطلب
9. صلاحية مدى الحياة



CSV 01



CSV 07

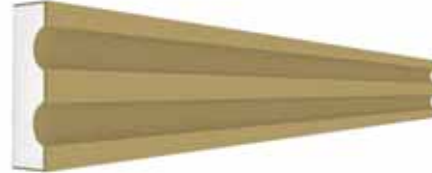

CSV 02



CSV 08

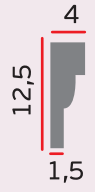

CSV 03

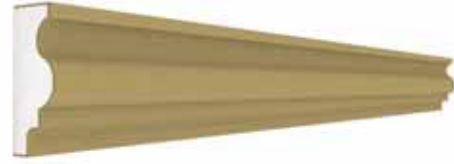

CSV 09



CSV 04

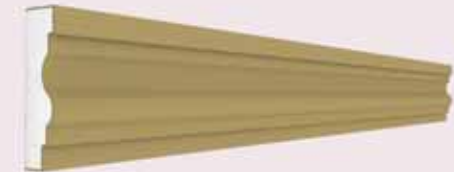

CSV 10

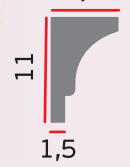

CSV 05



CSV 11

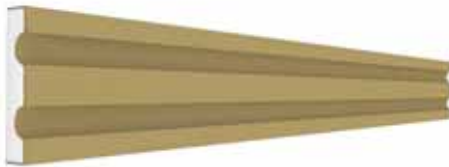
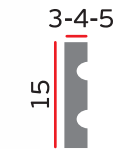

CSV 06



CSV 12

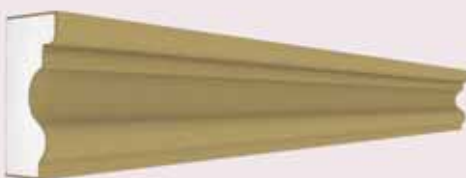

CSV 13

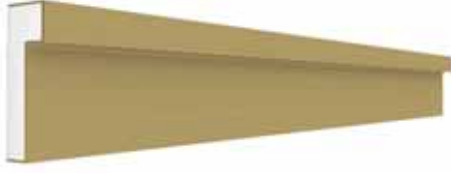

CSV 19

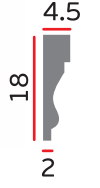

CSV 14



CSV 20

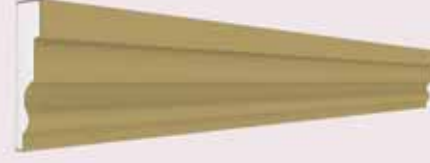

CSV 15

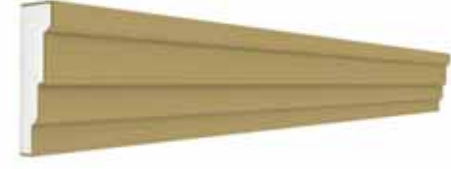

CSV 21

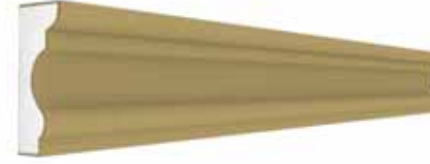

CSV 16

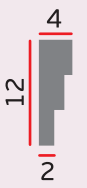

CSV 22

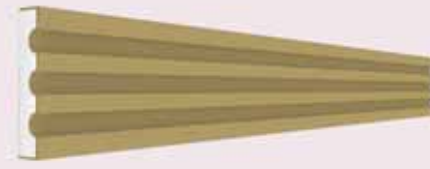

CSV 17



CSV 23

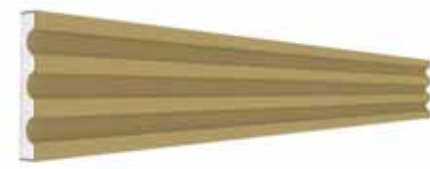

CSV 18

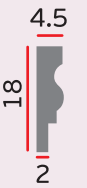

CSV 24



CSV 25

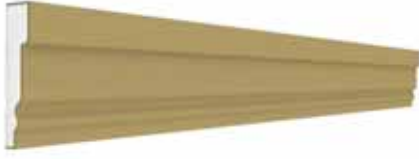
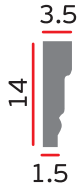

CSV 31



CSV 26

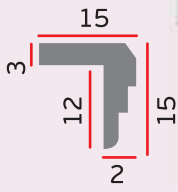

CSV 33



CSV 27

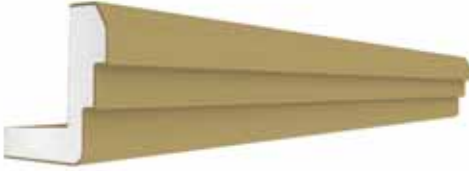
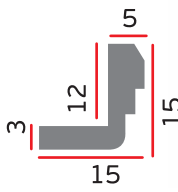

CSV 34



CSV 28

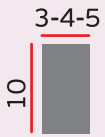

CSV 35

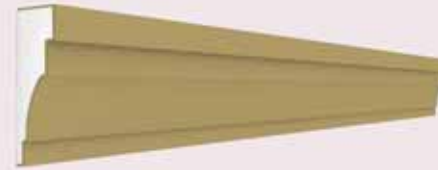
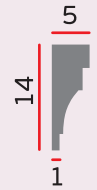

CSV 29

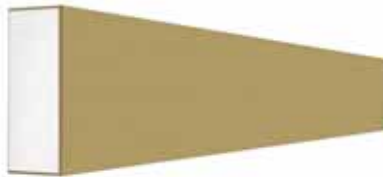
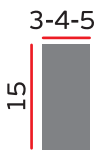

CSV 38

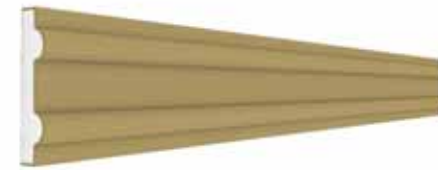

CSV 30

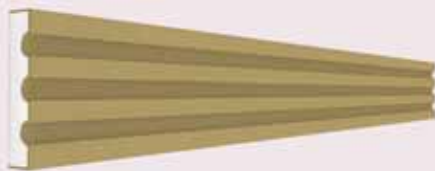

CSV 39

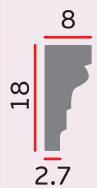

CSV 40

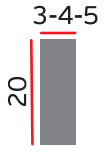

CSV 51



CSV 41



CSV 52



CSV 42

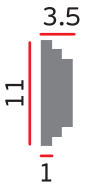

CSV 55

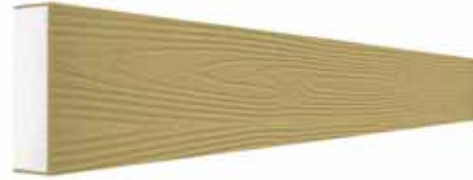
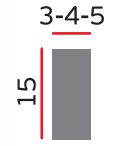

CSV 44

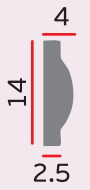

CSV 56

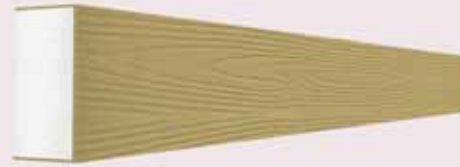
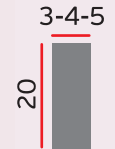

CSV 46

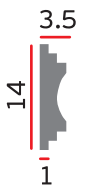

CSV 57

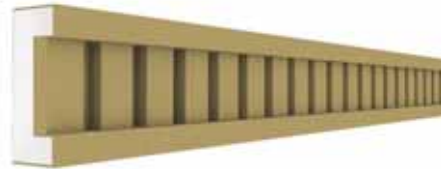
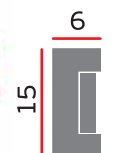

CSV 50

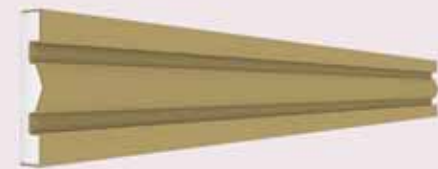

CSV 58



CSV 59

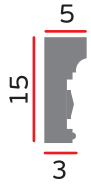

CSV 65

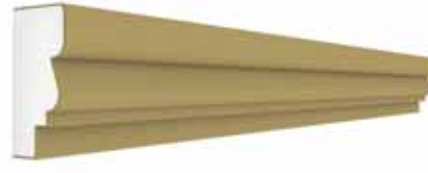

CSV 60

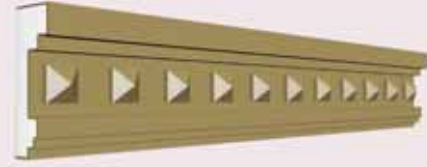
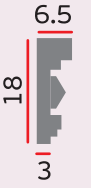

CSV 66

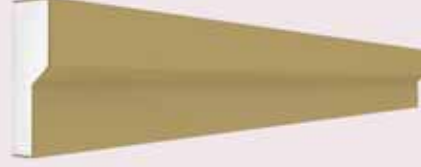

CSV 61

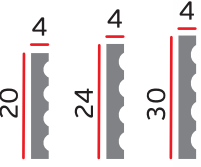

CSV 67

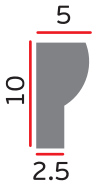

CSV 62

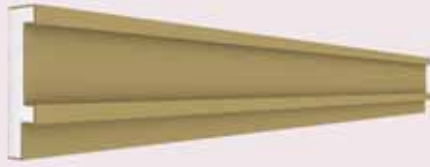
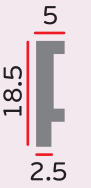

CSV 68

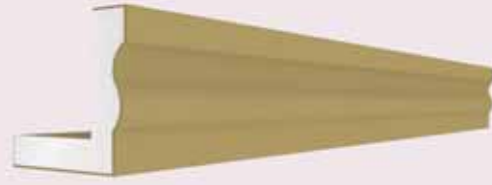
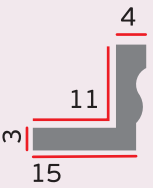

CSV 63



LAMBİRİ

CSV 69

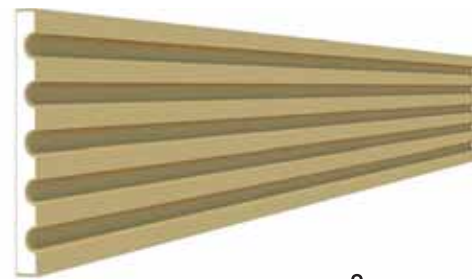

CSV 64

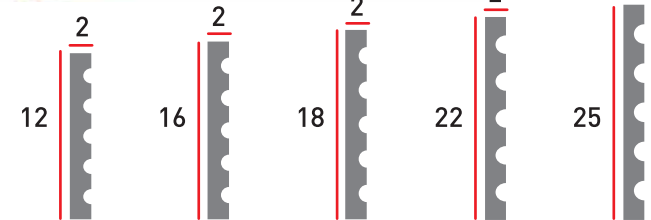

Ürünümüz XPS hammaddeneden üretilmektedir.



CSV 70

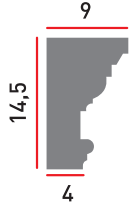

CSV 71

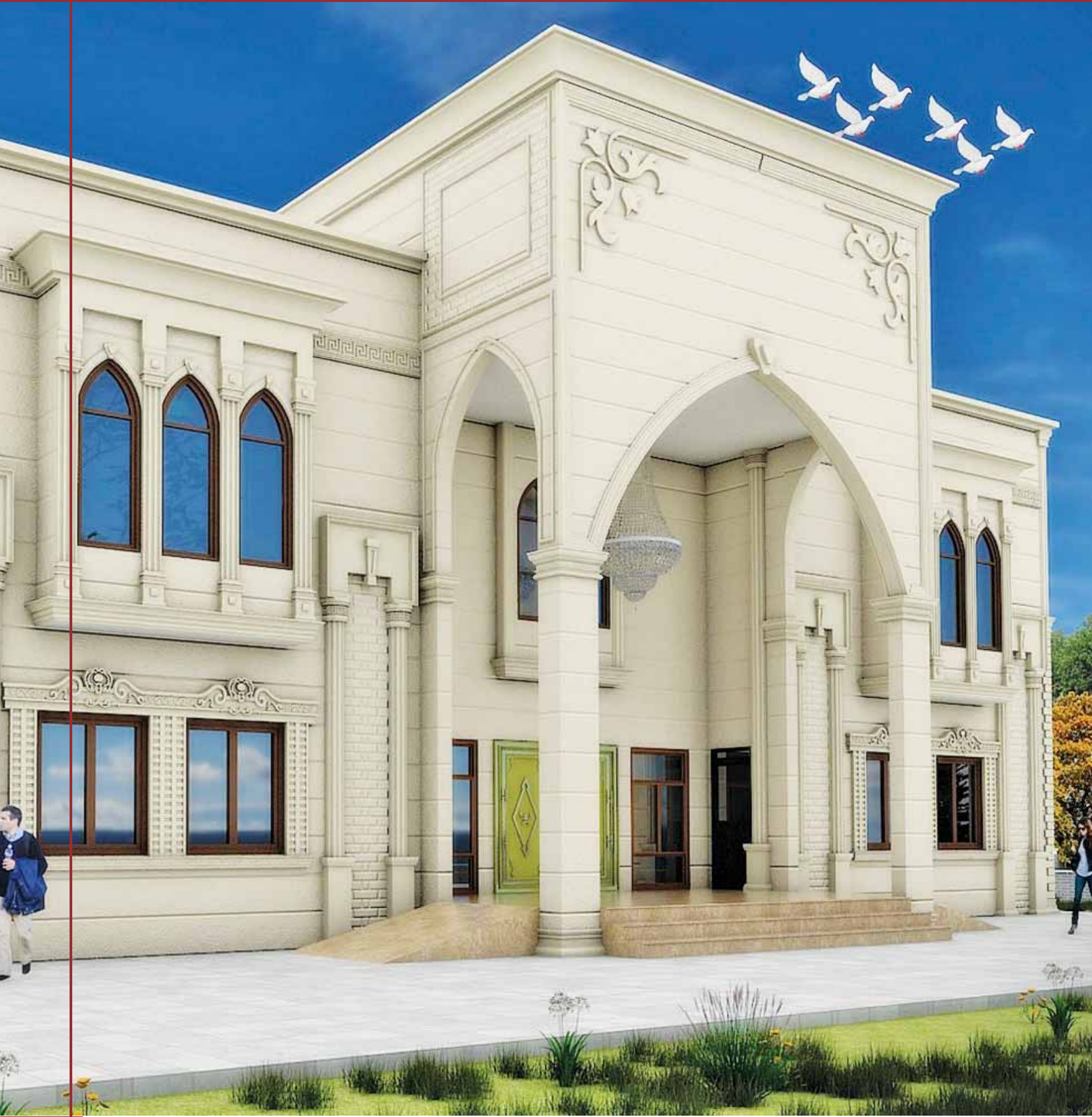
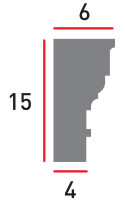



CTAÇ 01

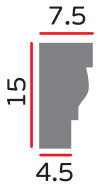

CTAÇ 07

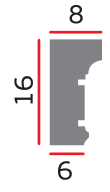

CTAÇ 02



CTAÇ 08

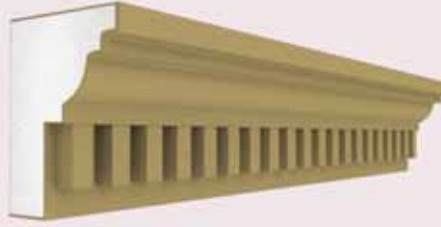
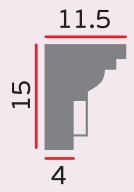

CTAÇ 03

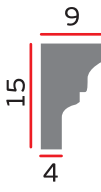

CTAÇ 09

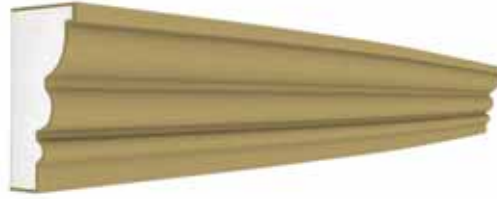

CTAÇ 04

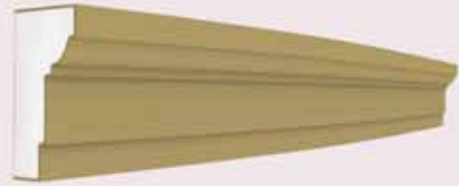

CTAÇ 10

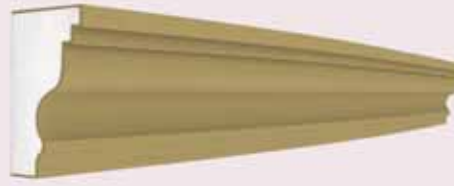
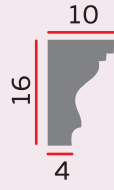

CTAÇ 05

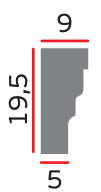

CTAÇ 11



CTAÇ 06

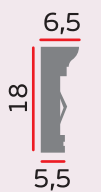

CTAÇ 12



CTAÇ 13



CTAÇ 19

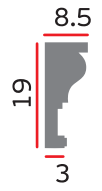

CTAÇ 14



100

CTAÇ 20

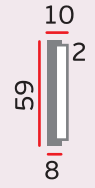

CTAÇ 15



CTAÇ 21



CTAÇ 16

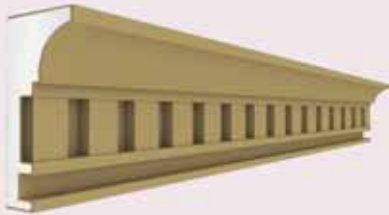

CTAÇ 22

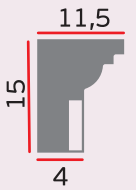

CTAÇ 17



CTAÇ 23



CTAÇ 18

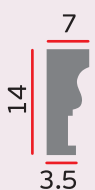

CTD 01



● 80x25x5 ● 100x30x5 ● 120x35x5

CTD 07



● 80x25x5 ● 100x30x5 ● 120x35x5

CTD 02



● 80x52x5 ● 100x53x5 ● 120x63x5

CTD 08



● 80x25x5 ● 100x30x5 ● 120x35x5

CTD 03



● 80x25x5 ● 100x30x5 ● 120x35x5

CTD 09



● 80x25x5 ● 100x30x5 ● 120x35x5

CTD 04



● 80x25x5 ● 100x30x5 ● 120x35x5

CTD 12



● 80x25x5 ● 100x30x5 ● 120x35x5

CTD 05



● 80x25x5 ● 100x30x5 ● 120x35x5

CTD 13



● 80x25x5 ● 100x30x5 ● 120x35x5

CTD 06



● 80x25x5 ● 100x30x5 ● 120x35x5

CTD 14



● 80x25x5 ● 100x30x5 ● 120x35x5

CTD 15



● 80x16x5 ● 100x20x5 ● 120x24x5

CTD 20



● 100x37x5 ● 120x37x5 ● 150x37x5 ● 200x37x5

CTD 16



● 80x22x5 ● 100x27x5 ● 120x32x5

CTD 21



● 100x35x5 ● 120x42x5

CTD 17



● 80x24x5 ● 100x30x5 ● 120x36x5

CTD 22



● 150x50x7 ● 200x50x7

CTD 18



● 80x24x5 ● 100x30x5 ● 120x36x5

CTD 23



● 150x50x8 ● 120x40x8 ● 310x80x10

CTD 19



● 80x37x5 ● 100x46x5 ● 120x55x5

TÜM ÇTD MODELLERİMİZDE  
ÖZEL ÖLÇÜDE  
SİPARİŞ VEREBİLİRSİNİZ.

Denizlik ve Taç Kapak  
Sail and Crown Cover / العتبات وغطاء التاج

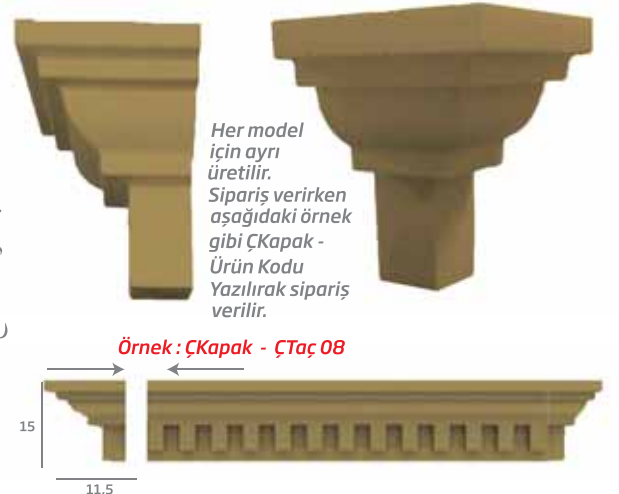

Her model için ayrı üretilir. Sipariş verirken aşağıdaki örnek gibi ÇKapak - Ürün Kodu Yazılı olarak sipariş verilir.

Örnek: ÇKapak - ÇTaç 08

Tüm Denizlik ve Taç Modellerine Göre Üretilmektedir. It can be produced according to all Sail and crown models.

تستطيع أن تنتج حسب كل موديلات العتبات و التاج



CDN 02



CDN 08



CDN 03

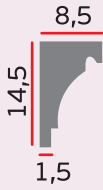

CDN 09

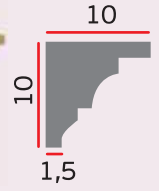

CDN 04



CDN 10



CDN 05



CDN 11



CDN 06



CDN 12



CDN 07



CDN 13

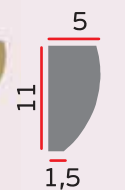



CDN 14

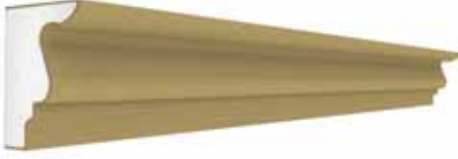

CDN 18

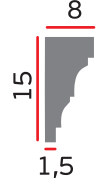

CDN 15

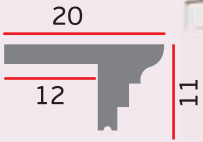

CDN 19

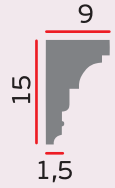

CDN 16

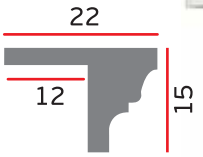

CDN 20



CDN 17

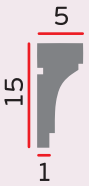

CDN 21



EN İYİ KALİTE YAPIŞTIRICILAR

**cukurova**<sup>®</sup>  
Fix|polistren dekor

AİLESİNDE



CKS 01

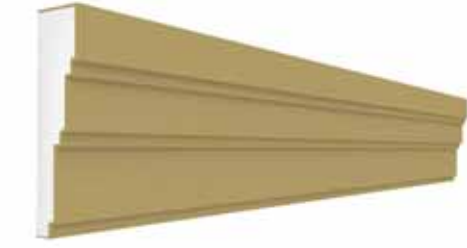

CKS 08



CKS 02



CKS 09



CKS 04



CKS 10

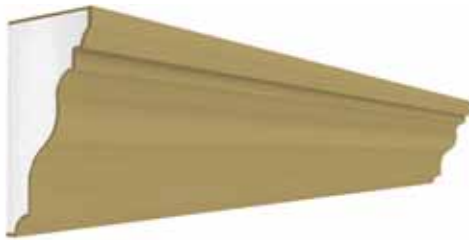

CKS 05

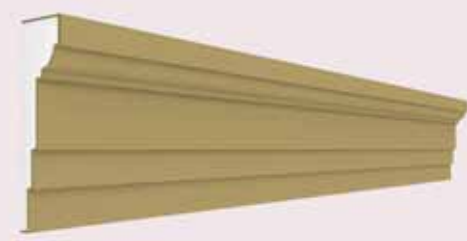

CKS 11

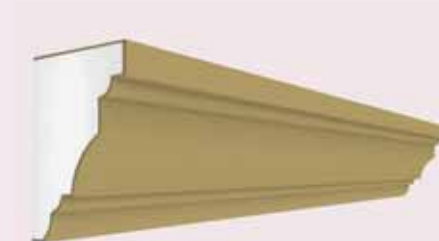

CKS 06

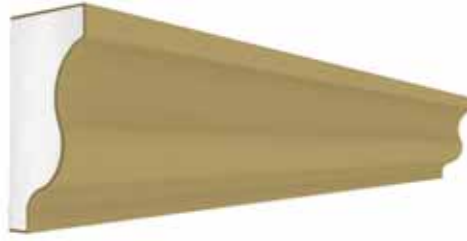

CKS 12



CKS 07

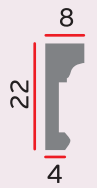

CKS 13

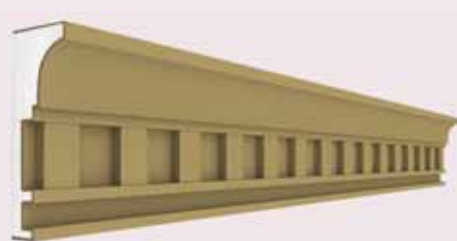

CKS 14

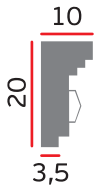

CKS 20



CKS 15

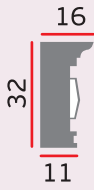

CKS 21

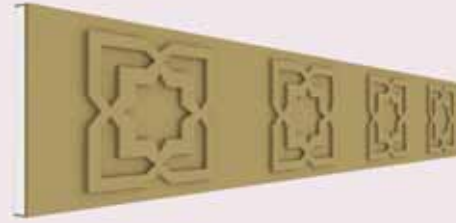

CKS 16

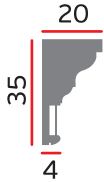

CKS 22



CKS 17

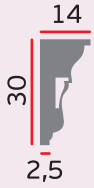

CKS 23

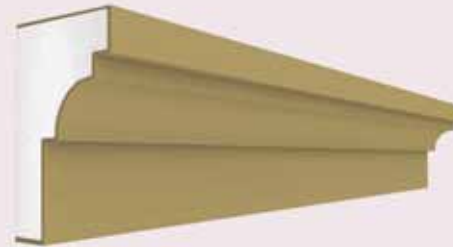

CKS 18



CKS 24

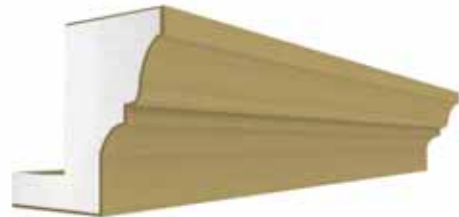
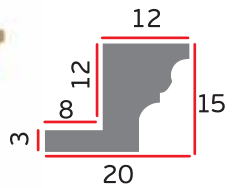

CKS 19

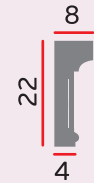

CKS 27

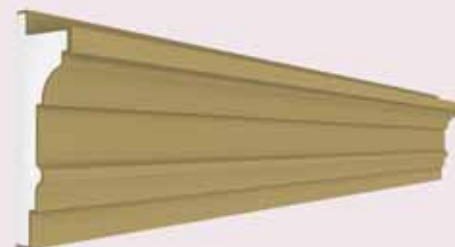

CKS 28

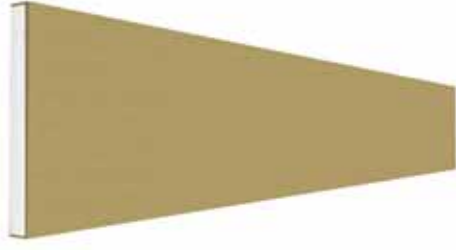

CKS 35

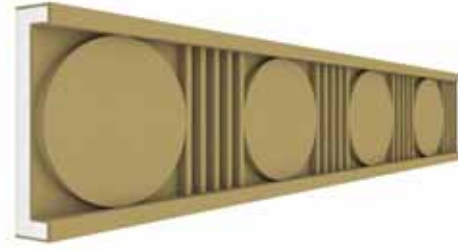

CKS 30

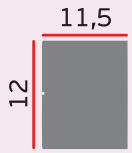

CKS 37



CKS 31



CKS 38

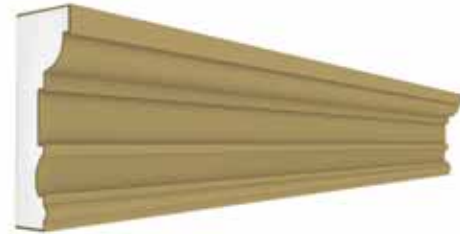

CKS 32

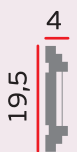

CKS 39



CKS 33

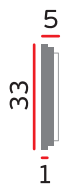

CKS 40

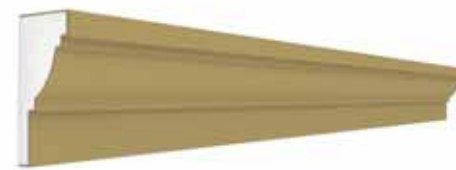
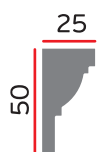

CKS 34

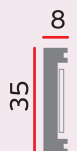

CKS 41





CKS 42



CKS 47

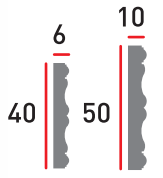

CKS 43

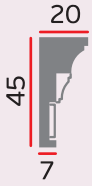

CKS 48

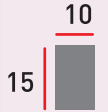

CKS 44



CKS 49

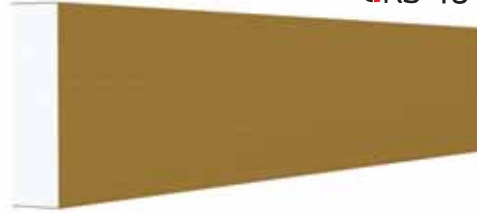
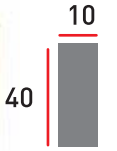

CKS 45

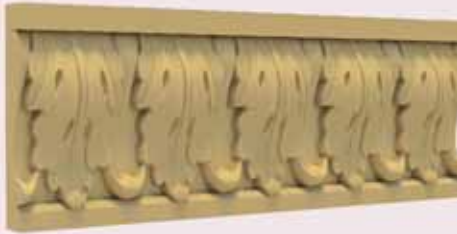
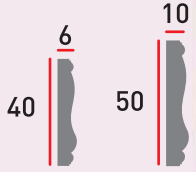

CKS 50

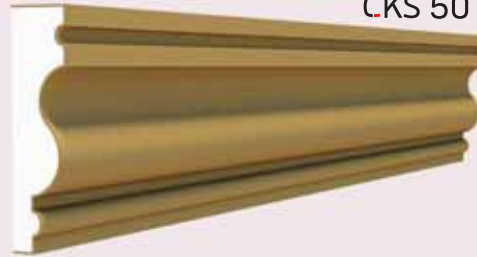

CKS 46

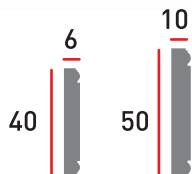



CHP 01

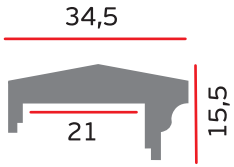

CHP 03

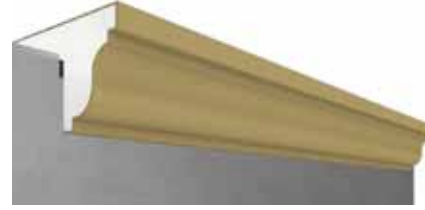
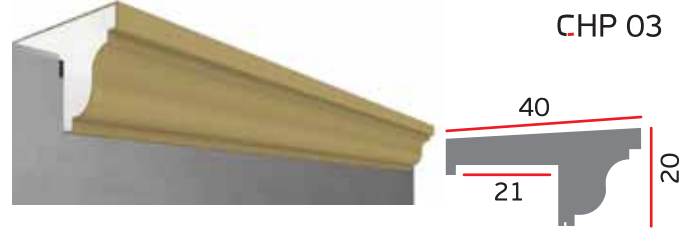

CHP 02

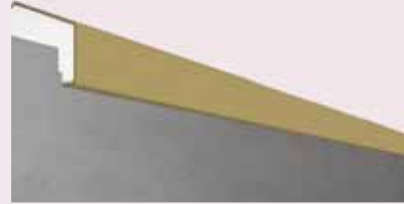
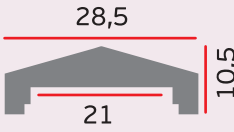

CHP 04

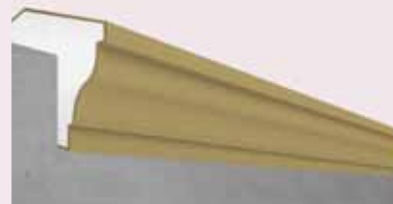
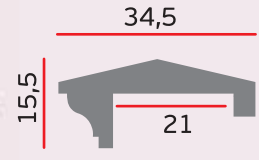

Insulator Bauliban  
بوليبان عازل

CMT 01

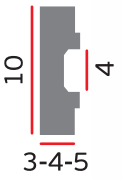

Mantolama ıtısı

CMT 03

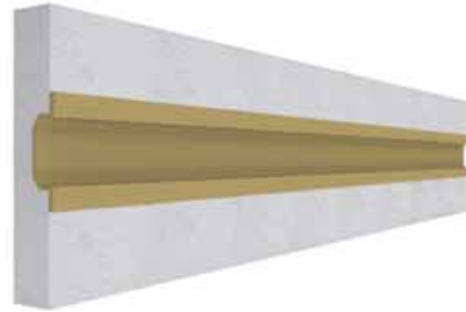
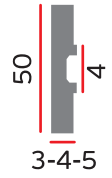

CMT 02

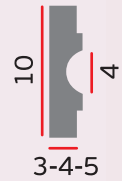

CMT 04

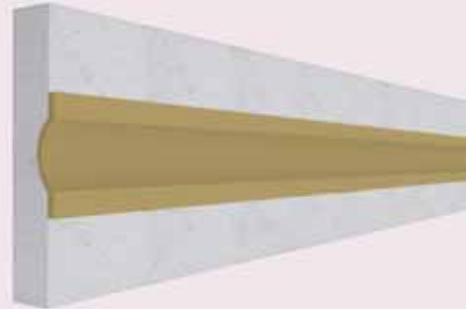

Window Corner Decor  
ديكورات زوايا النافذة

CYP 01

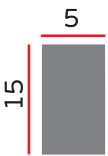

CYP 03

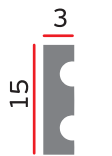

CYP 02

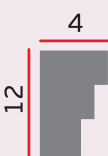

CYP 04

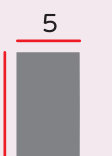

Yuvarlak Pencere

CÇT 01



CÇT 10

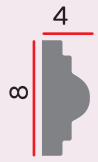

CÇT 02



CÇT 11

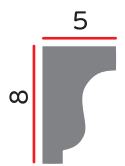

CÇT 03

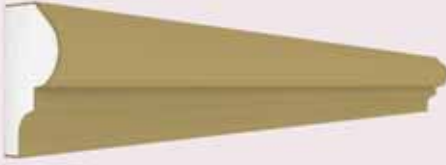

CÇT 12

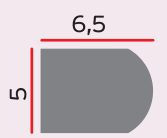

CÇT 04

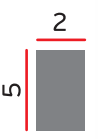

CÇT 13

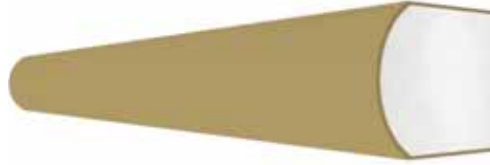
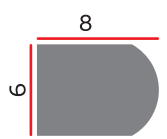

CÇT 05

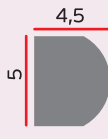

CÇT 14

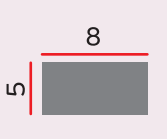

CÇT 06



CÇT 15

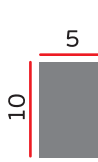

CÇT 07

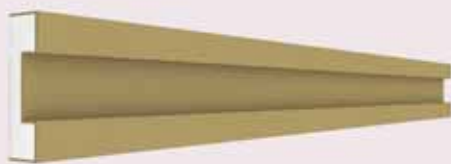

CÇT 16

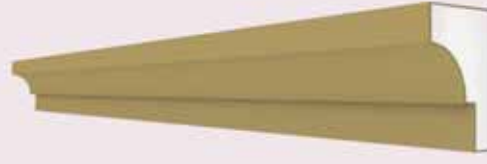

CÇT 08

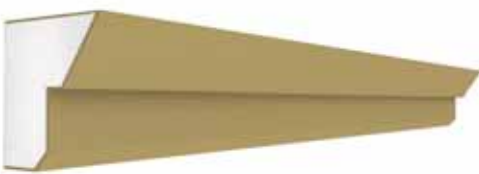
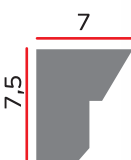

CÇT 17

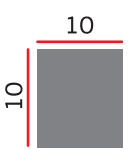

CKE 01

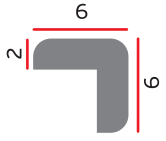

CKE 16

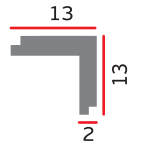

CKE 02

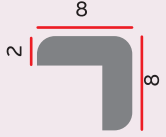

CKE 17

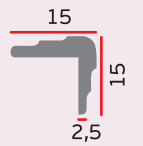

CKE 03

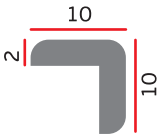

CKE 19

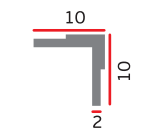

CKE 04

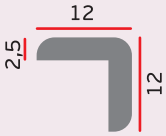

CKE 26

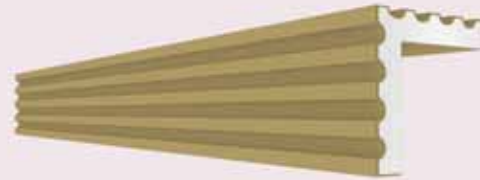
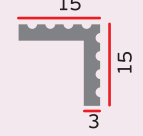

CKE 05

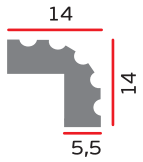

CKE 27

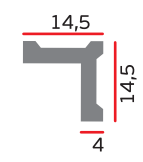

CKE 11

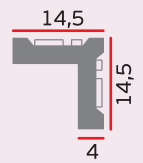

CKE 28

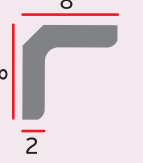

CKE 12

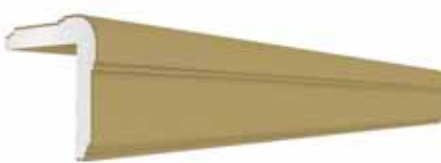
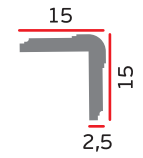

CKE 29

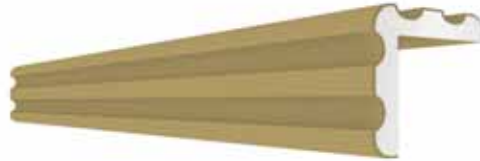
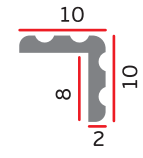

CKE 15

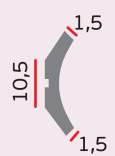

CKE 13



CKE 14



CKE 18

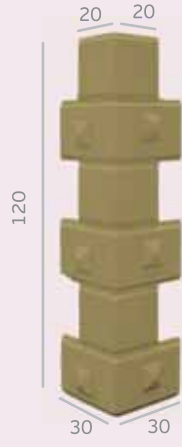

CKE 20



CKE 21



CKE 22

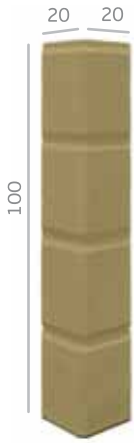

CKE 24

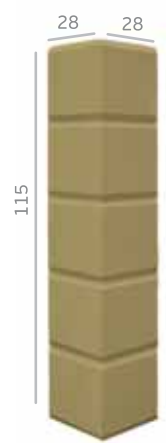

CKE 30



CKE 31

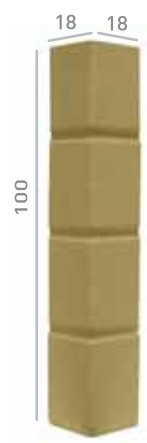

CKE 32



CKE 33



CKE 34



CKE 35



CKE 36



CKE 37

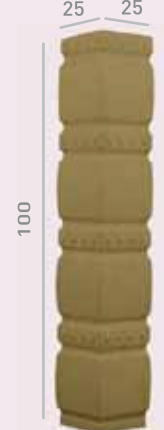



Pipe Closing  
أنبوب إغلاق

**CUKUROVA®**  
polistren dekor

Boru Kaplama



CBK 01



- Ø 10
- Ø 12
- Ø 18



CBK 02

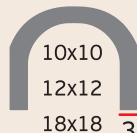

- Ø 10
- Ø 12
- Ø 18



CBK 03

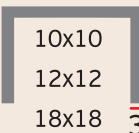

- Ø 10
- Ø 12
- Ø 18



CBK 04



- Ø 10
- Ø 12
- Ø 18



CBK 05

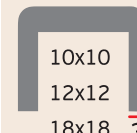

- Ø 10
- Ø 12
- Ø 18



CBK 06



- Ø 10
- Ø 12
- Ø 18

Column  
دنة

**CUKUROVA®**  
polistren dekor

Kolon

CKLN 01

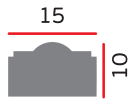

CKLN 09

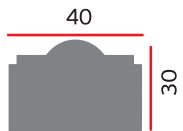

CKLN 02

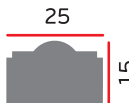

CKLN 10

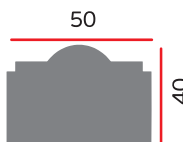

CKLN 03

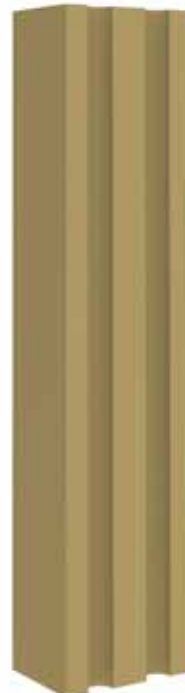
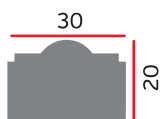

CKLN 04

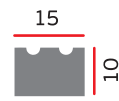

CKLN 05

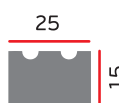

CKLN 06

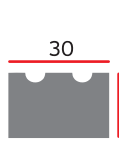

CKLN 07

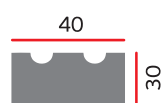

CKLN 08

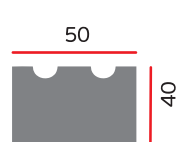

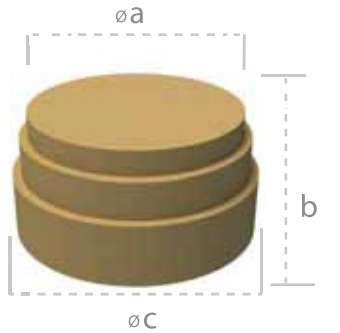
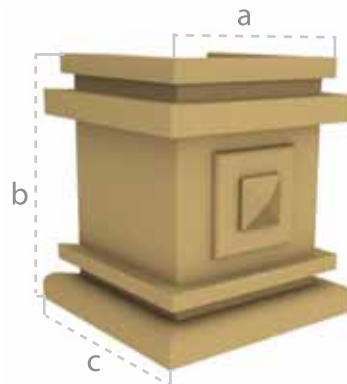
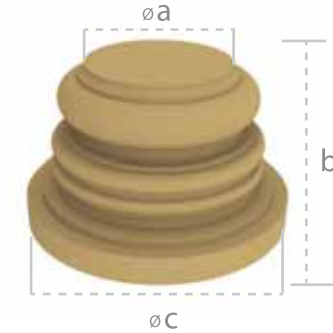
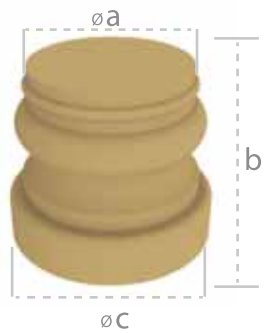
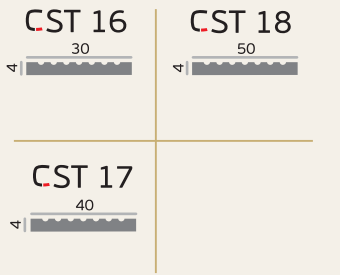
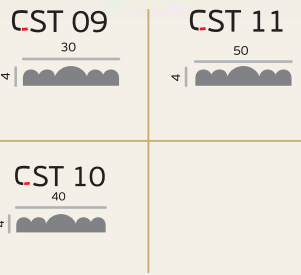
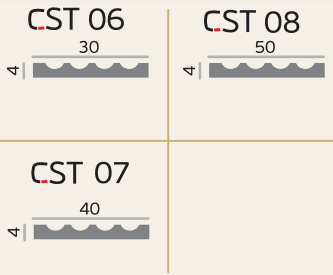
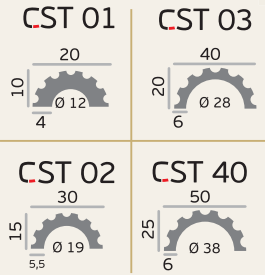
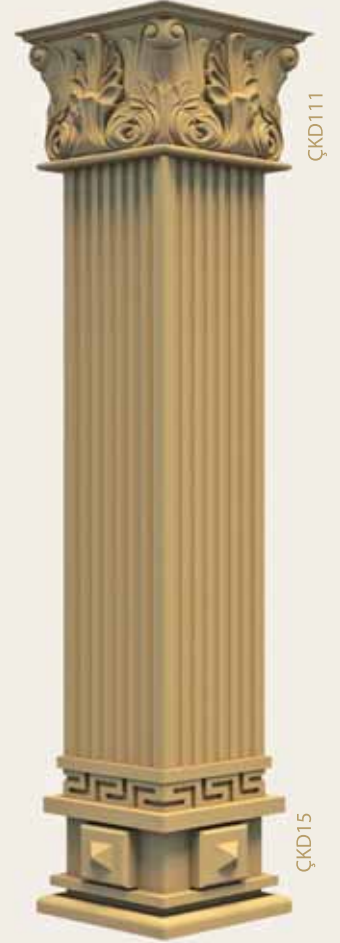
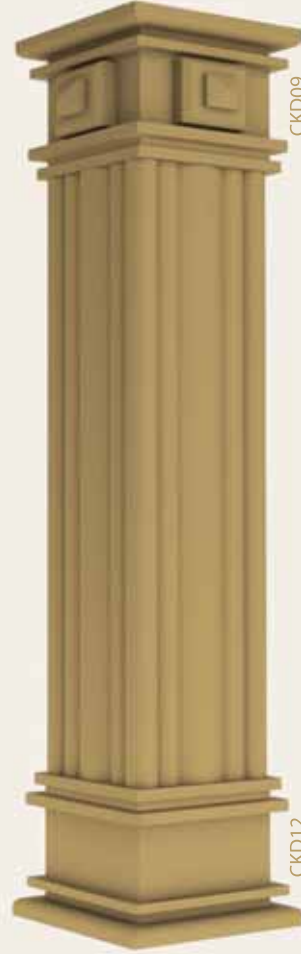
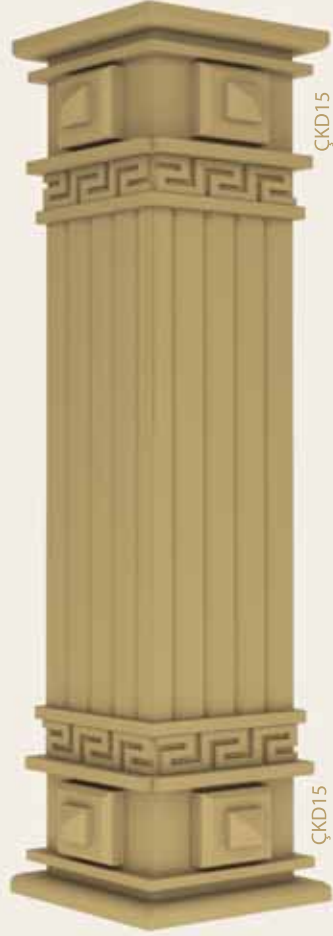

CKD 01	Øa:22 Øc:30 b:25	CKD 03	Øa:42 Øc:50 b:25
CKD 02	Øa:32 Øc:40 b:25	CKD 88	Øa:52 Øc:60 b:25

CKD 06	Øa:22 Øc:30 b:25	CKD 22	Øa:42 Øc:50 b:25
CKD 21	Øa:32 Øc:40 b:25		

CKD 20	a:22 c:11 b:40	CKD 04	a:32 c:16 b:40
CKD 05	a:42 c:21 b:40	CKD 89	a:52 c:26 b:40

CKD 07	Øa:22 Øc:30 b:25	CKD 24	Øa:42 Øc:50 b:25
CKD 23	Øa:32 Øc:40 b:25		



ÇKD20

ÇKD20

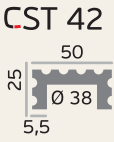
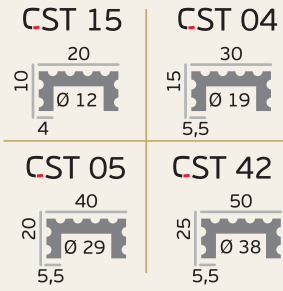

ÇKD18

ÇKD12

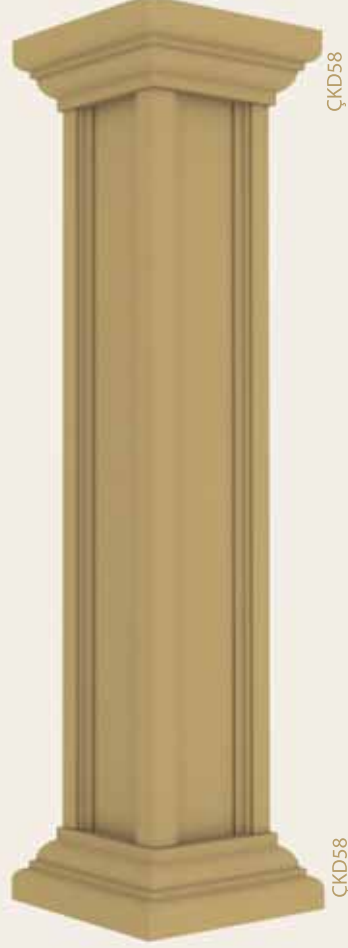
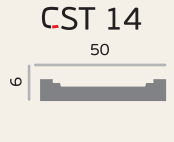
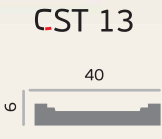
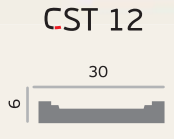
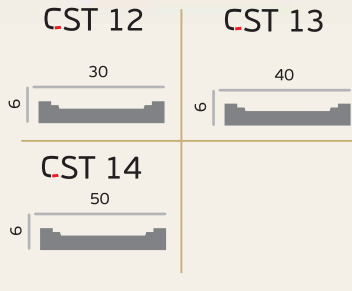

ÇKD58

ÇKD58

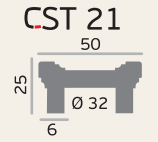
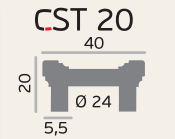
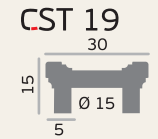
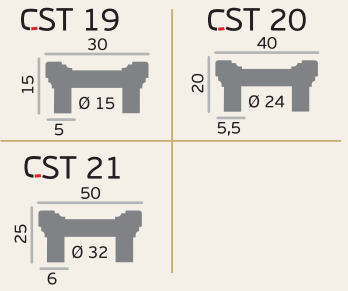

ÇKD81

ÇKD51

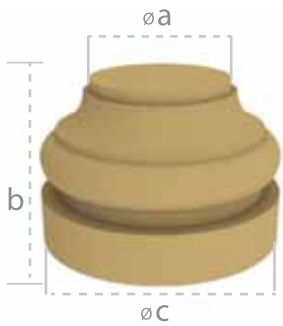
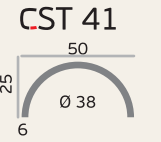
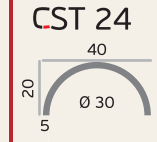
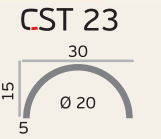
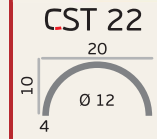
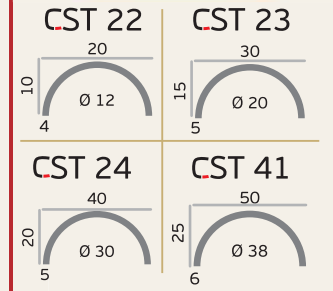

CKD 08	øa:22	CKD 26	øa:42
	øc:30		øc:50
	b:25		b:25
CKD 25	øa:32	CKD 90	øa:52
	øc:40		øc:60
	b:25		b:25

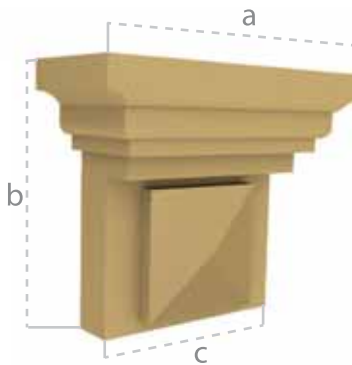

CKD 18	a:40	CKD 30	a:60
	c:33		c:53
	b:25		b:25
CKD 29	a:50	12 cm.	
	c:43	kalınlığında	
	b:25	üretilmektedir.	

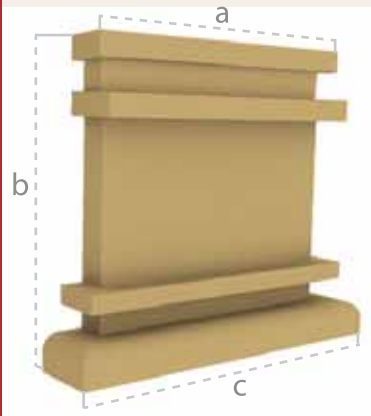

CKD 12	a:33	CKD 14	a:53
	c:40		c:60
	b:40		b:40
CKD 13	a:43	5 cm	
	c:50	kalınlığında	
	b:40	üretilmektedir.	

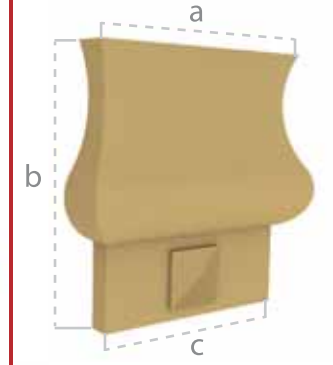

CKD 19	a:40	CKD 32	a:60
	c:33		c:53
	b:35		b:35
CKD 31	a:50	7 cm.	
	c:43	kalınlığında	
	b:35	üretilmektedir.	



CST 25    CST 26



CST 27



CST 28    CST 29



CST 30    CST 43



CST 31    CST 32



CST 33    CST 44

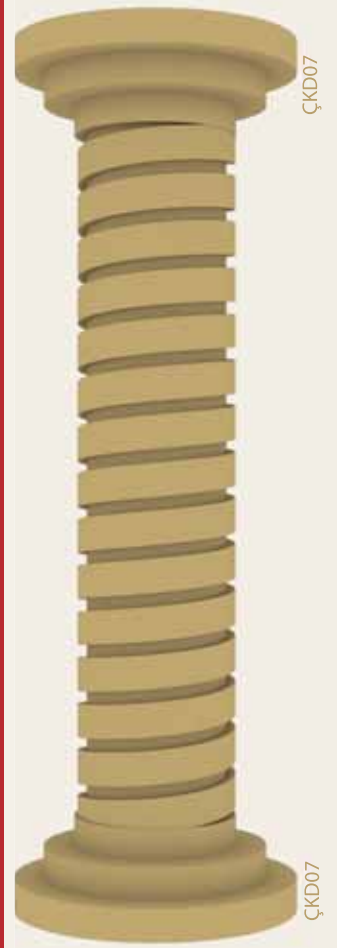

CST 34    CST 35



CST 36    CST 45

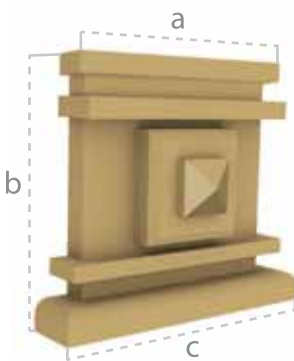

CKD 09	a:33 c:40 b:40	CKD 11	a:53 c:60 b:40
CKD 10	a:43 c:50 b:40	5 cm kalınlığında üretilmektedir.	

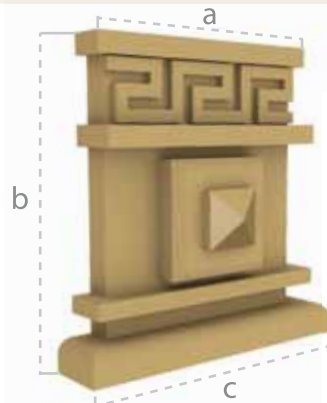

CKD 15	a:33 c:40 b:40	CKD 17	a:53 c:60 b:40
CKD 16	a:43 c:50 b:40	8 cm kalınlığında üretilmektedir.	

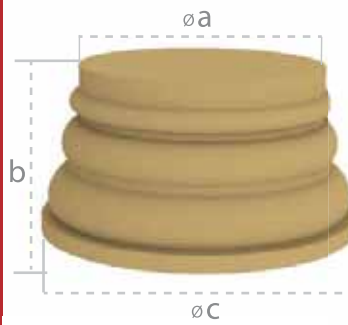

CKD 33	øa:22 øc:30 b:15	CKD 35	øa:42 øc:50 b:15
CKD 34	øa:32 øc:40 b:15	CKD 91	øa:52 øc:60 b:15

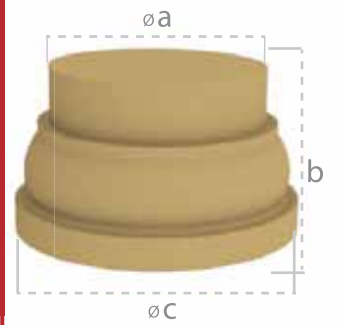

CKD 36	øa:22 øc:30 b:15	CKD 38	øa:42 øc:50 b:15
CKD 37	øa:32 øc:40 b:15	CKD 92	øa:52 øc:60 b:15



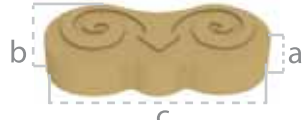

CKD 55	a:14 c:35 b:20	CKD 56	a:18 c:45 b:25
CKD 54	a:10 c:25 b:15		

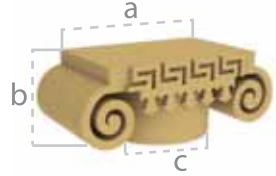

CKD 72	a:54 c:22 b:19,5	CKD 74	a:103 c:42 b:37,5
CKD 73	a:78,5 c:32 b:28,5		

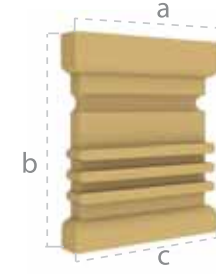

CKD 66	a:32 c:32 b:30	CKD 68	a:52 c:52 b:30
CKD 67	a:42 c:42 b:30	4 cm kalınlığında üretilmektedir	

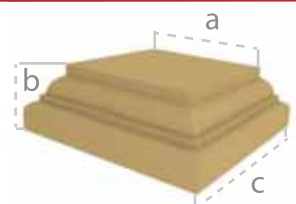

CKD 58	a:42 c:55 b:15	CKD 59	a:52 c:65 b:15
CKD 57	a:32 c:45 b:15		



CKD 60	a:30 c:42 b:15	CKD 62	a:50 c:62 b:15
CKD 61	a:40 c:52 b:15		

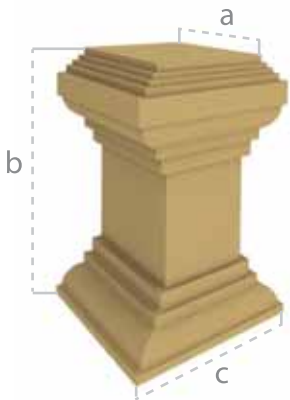
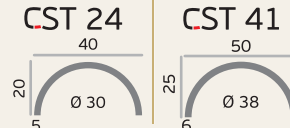
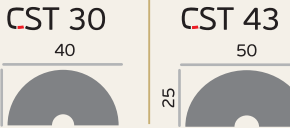
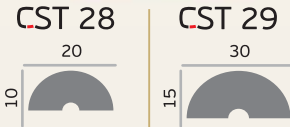
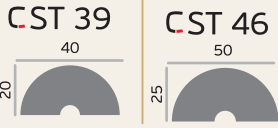
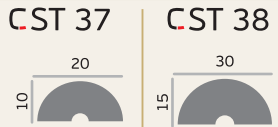

CKD 51	a:22 c:32 b:50	CKD 53	a:42 c:52 b:100
CKD 52	a:32 c:42 b:80		

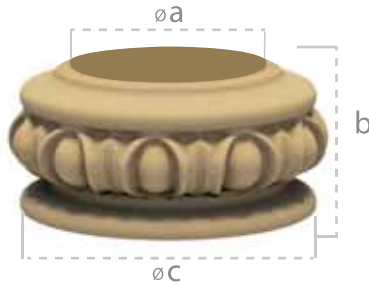

CKD 115	øa:22 øc:30 b:15	CKD 117	øa:42 øc:50 b:22
CKD 116	øa:32 øc:40 b:15		

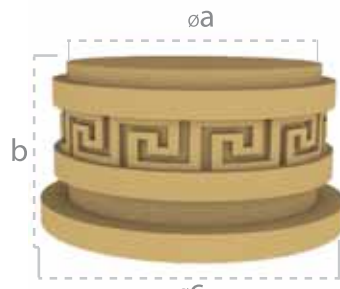

CKD 69	øa:22 øc:30 b:32	CKD 71	øa:52 øc:60 b:32
CKD 70	øa:42 øc:50 b:32	CKD 72	øa:32 øc:40 b:32



CST 47

30



CST 49

50



CST 48

40



CST 50

Ø30



CST 52

Ø50



CST 51

Ø40



CST 53

Ø30



CST 55

Ø50



CST 54

Ø40

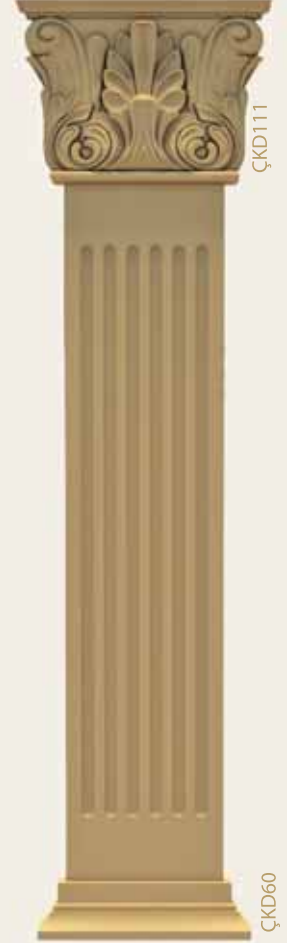

CST 56

30

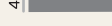

CST 58

50

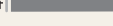

CST 57

40

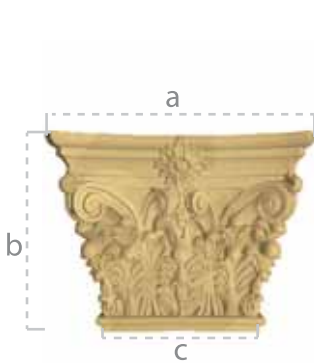
 CKD 75  
 a:35  
 c:22  
 b:40

 CKD 77  
 a:65  
 c:42  
 b:50

 CKD 76  
 a:50  
 c:32  
 b:50

 CKD 78  
 a:80  
 c:52  
 b:50

 CKD 81  
 a:32  
 c:22  
 b:40

 CKD 83  
 a:60  
 c:42  
 b:50

 CKD 82  
 a:46  
 c:32  
 b:50

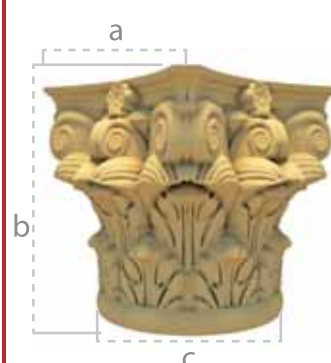
 CKD 84  
 a:75  
 c:52  
 b:50

 CKD 96  
 a:51  
 c:32  
 b:50

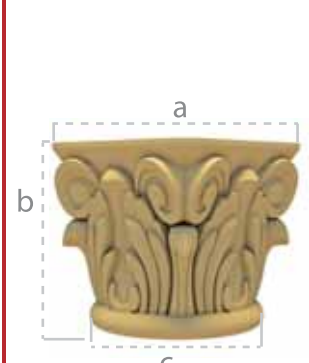
 CKD 98  
 a:80  
 c:52  
 b:50

 CKD 97  
 a:64  
 c:42  
 b:50

 CKD 99  
 a:56,5  
 c:32  
 b:50

 CKD 101  
 a:79  
 c:52  
 b:50

 CKD 100  
 a:70,3  
 c:42  
 b:50



ÇKD81

ÇKD69

CST 22

CST 23

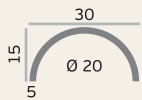
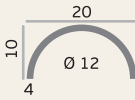

CST 24

CST 41

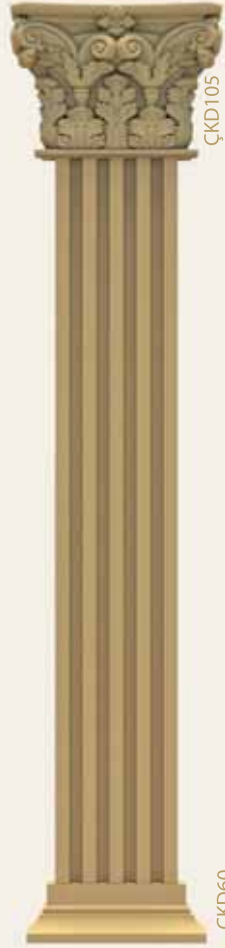
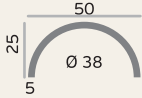
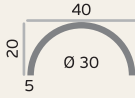

ÇKD105

ÇKD60

CST 16

CST 18



CST 17

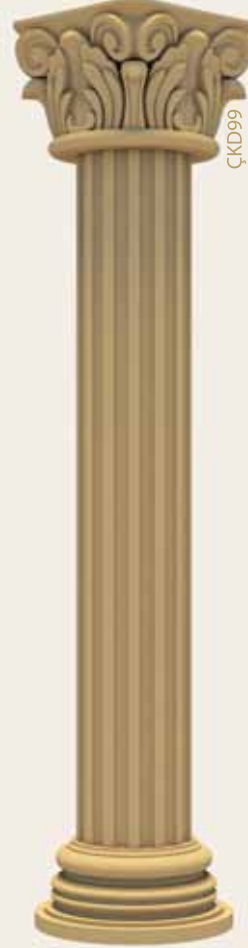

ÇKD99

ÇKD06

CST 01

CST 03

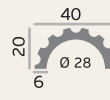
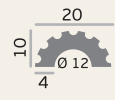

CST 02

CST 40

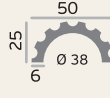
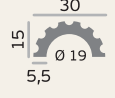

ÇKD81

ÇKD115

CST 22

CST 23

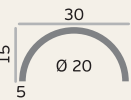
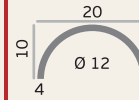

CST 24

CST 41

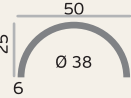
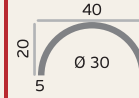

CKD 102

a:52  
c:32  
b:50

CKD 104

a:82  
c:52  
b:50

CKD 103

a:65  
c:42  
b:50



CKD 105

a:50  
c:35  
b:50

CKD 107

a:75  
c:55  
b:50

CKD 106

a:62  
c:45  
b:50  
16,5 cm  
kalınlığında  
üretilmektedir.

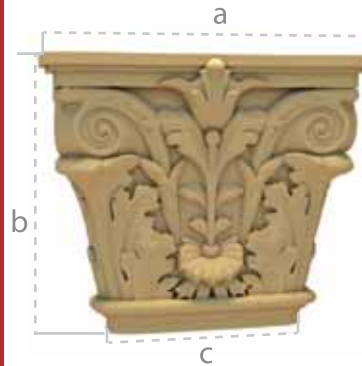

CKD 108

a:56  
c:35  
b:50

CKD 110

a:90  
c:55  
b:50

CKD 109

a:72  
c:45  
b:50  
15 cm  
kalınlığında  
üretilmektedir.



CKD 111

a:50  
c:35  
b:50

CKD 113

a:77  
c:55  
b:50

CKD 112

a:62  
c:45  
b:50  
12,5 cm  
kalınlığında  
üretilmektedir.



CBLS 01

CBLS 02

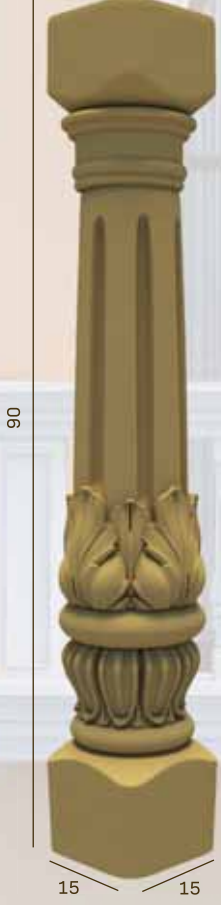

CBLS 03

ÇTAÇ 08

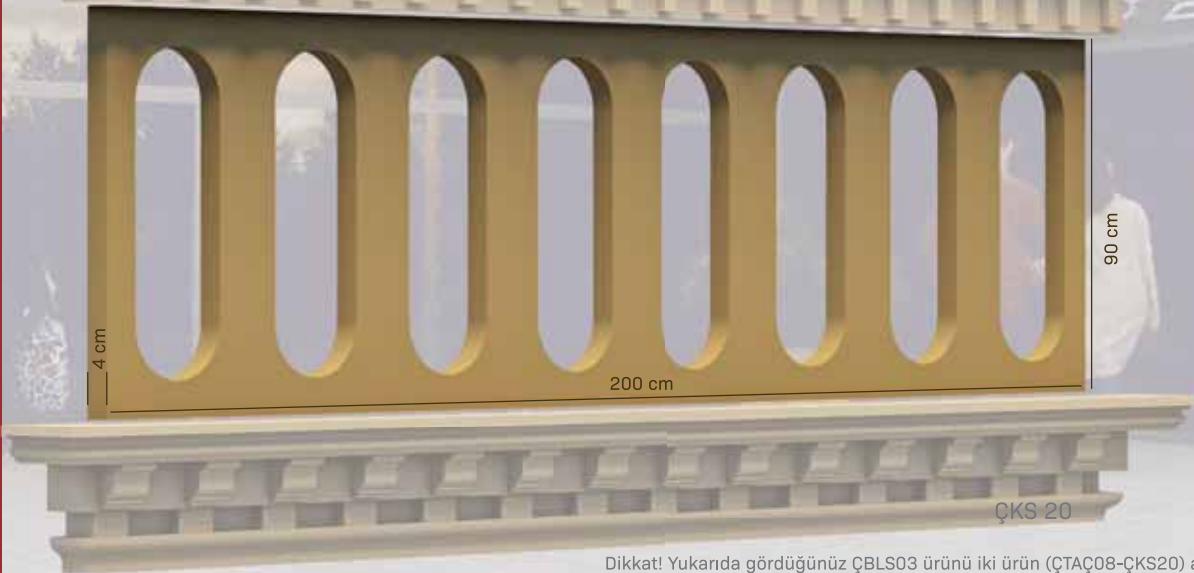

Dikkat! Yukarıda gördüğünüz ÇBLS03 ürünü iki ürün (ÇTAÇ08-ÇKS20) arasında kalan üründür. Diğer ürünler nasıl kullanılacağını göstermek amacıyla konulmuştur.



15-20-25-30 CPY 01

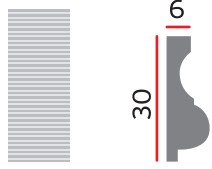

15-20-25-30 CPY 07

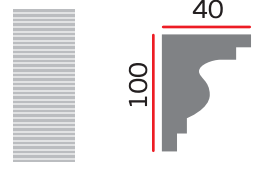

15-20-25-30 CPY 02

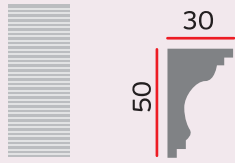

15-20-25-30 CPY 08

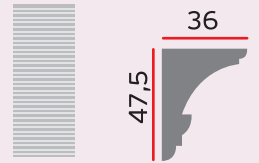

15-20-25-30 CPY 03

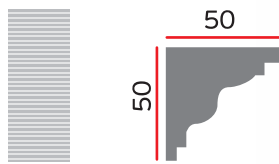

15-20-25-30 CPY 09

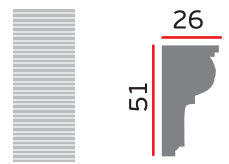

15-20-25-30 CPY 04

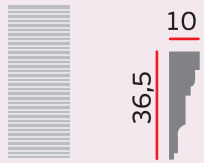

15-20-25-30 CPY 10

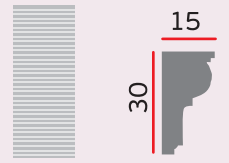

15-20-25-30 CPY 05

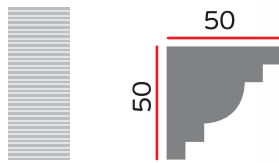

15-20-25-30 CPY 11

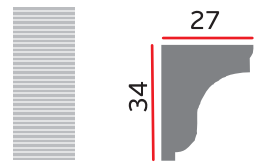

15-20-25-30 CPY 06

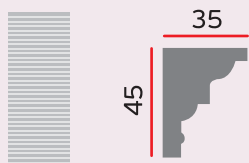

15-20-25-30 CPY 12

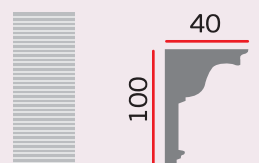

15-20-25-30 CPY 13



15-20-25-30 CPY 21

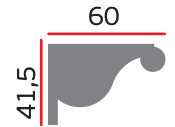

15-20-25-30 CPY 14

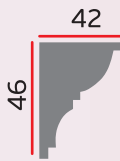

15-20-25-30 CPY 22

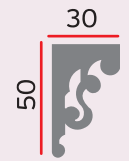

CPY 17



15-20-25-30 CPY 23

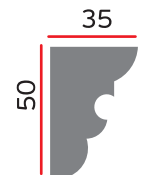

CPY 18

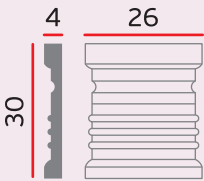

15-20-25-30 CPY 24

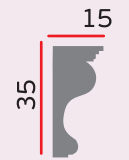

CPY 19

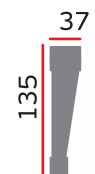

CPY 25



24



CPY 20



CPY 26

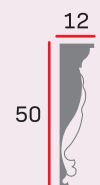

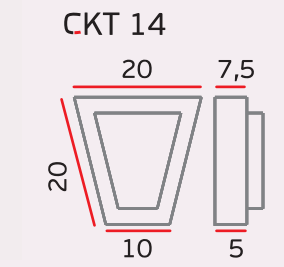
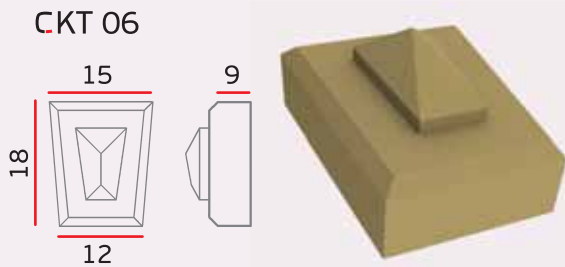
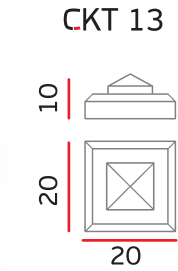
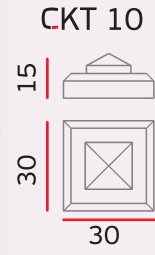
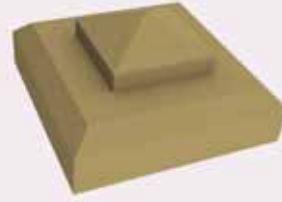
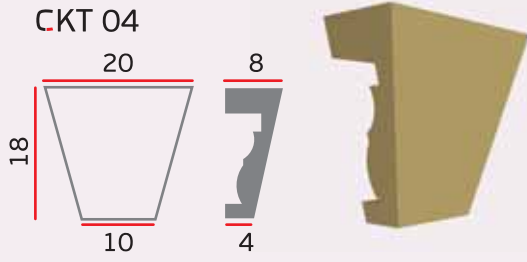
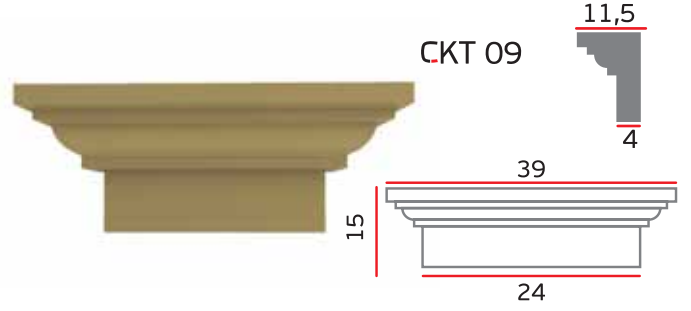
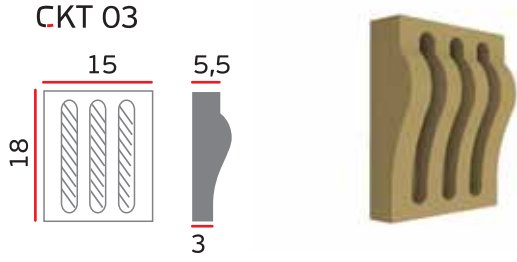
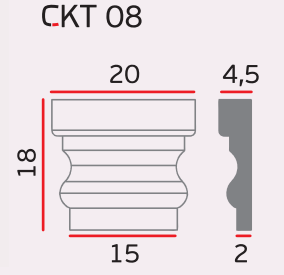
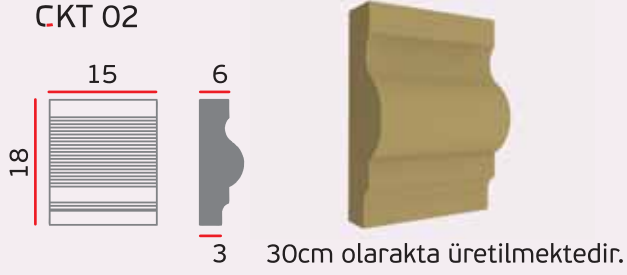
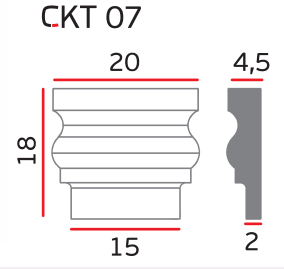
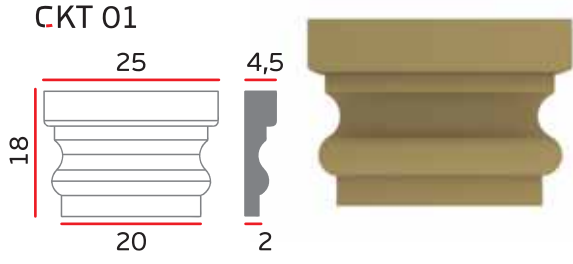

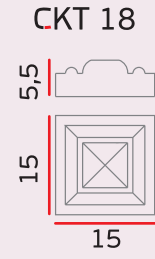
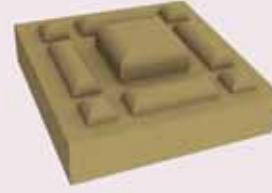
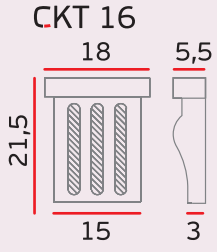
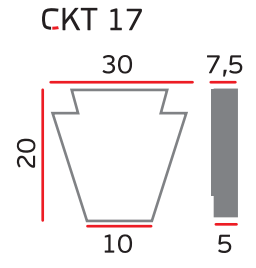
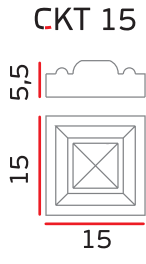

CKT 19

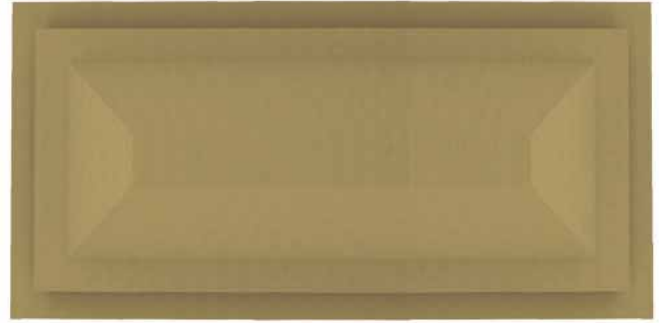
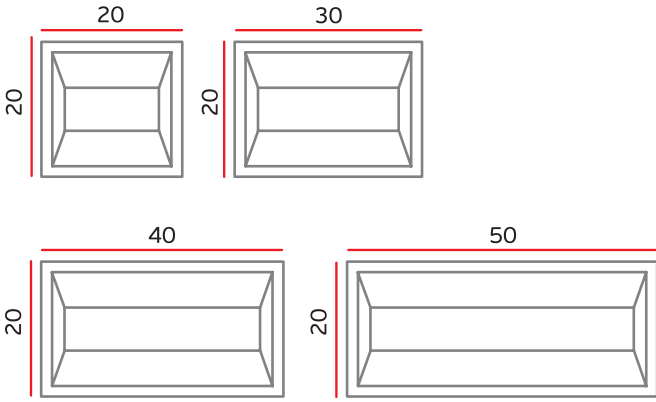



CRZ 01

50x50x7,5 cm



CRZ 05

50x50x6 cm

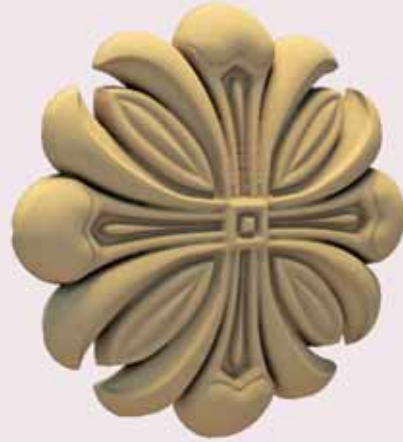

CRZ 02

50x50x5 cm



CRZ 06

50x50x7,5 cm



CRZ 03

50x50x5 cm



CRZ 07

75x75x5 cm



CRZ 04

50x50x6 cm

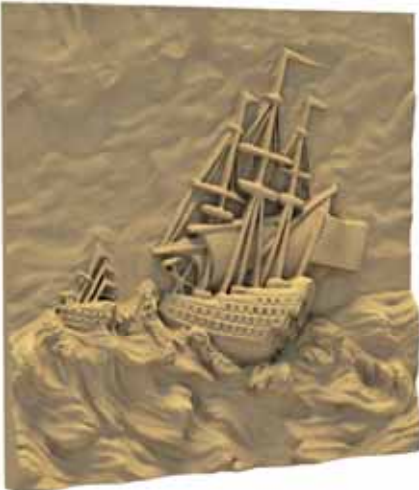

CRZ 08

50x50x6 cm



CAD 01  
20x19x3



CBS 06  
42x20x3

CAD 02  
29x29x3



CYD 03  
25x14x3

CAD 03  
15x9x3



CYD 02  
25x14x3

CBS 01  
63x30x3



CPKD 01  
32,5x32,5x3

CBS 02  
50x31x3



CPKD 02  
32,5x32,5x3

CBS 03  
35x33x3



CMTF 01  
50x50x3

CBS 04  
50x50x3



CMTF 02  
80x70x3

CBS 05  
50x50x3



CMTF 03  
100x50x3

CMTF 04  
50x32x3



CMTF 10  
50x100x5

CMTF 05  
56x56x3



CMTF 11  
50x100x5

CMTF 06  
100x50x3

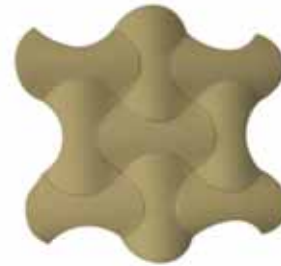

CMTF 13  
50x50x3

CMTF 07  
100x50x3



CMTF 14  
42x150x5

CMTF 08  
50x100x5



CMTF 15  
43x100x5

CMTF 09  
50x100x5



CMTF 16  
41x100x5



CMTF 17  
50x50x5



CMTF 24  
50x50x5



CMTF 18  
50x50x3



CMTF 25  
50x50x5



CMTF 19  
50x50x5



CMTF 26  
50x50x5



CMTF 20  
35x75x5



CMTF 27  
80x98,5x5



CMTF 21  
50x50x5



CMTF 28  
50x100x5

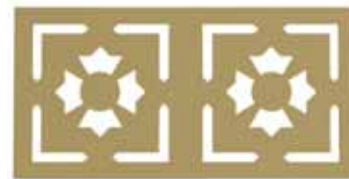

CMTF 23  
50x50x5



CMTF 30  
50x50x5







CFG 01

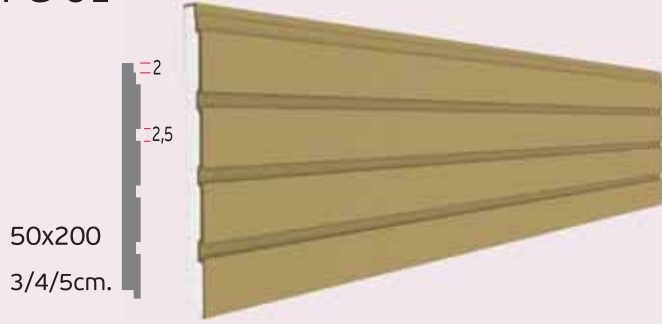

CFG 05

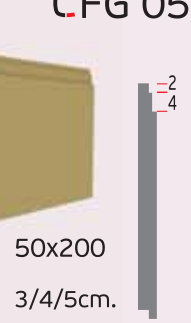

CFG 02

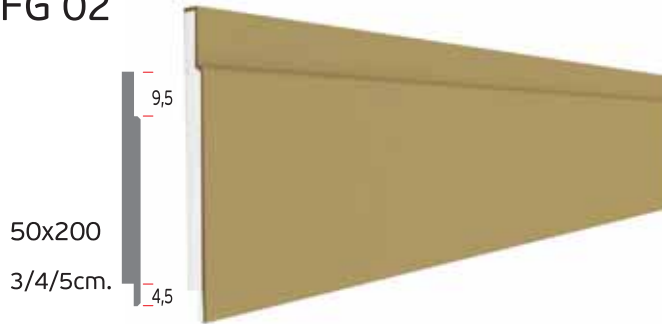

CFG 06

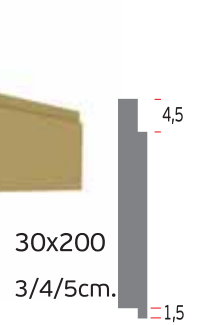

CFG 03

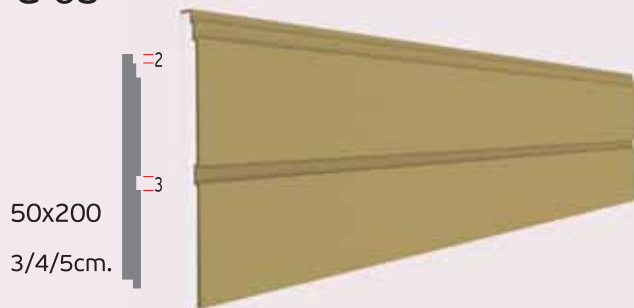

CFG 08

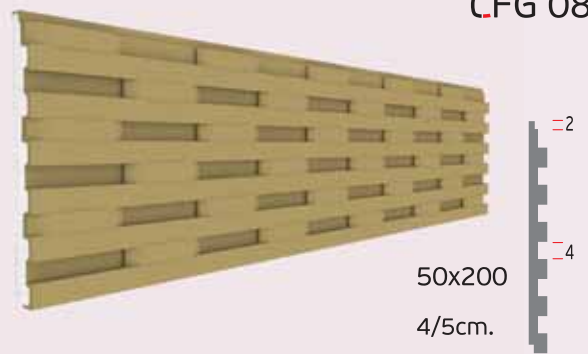

CFG 04

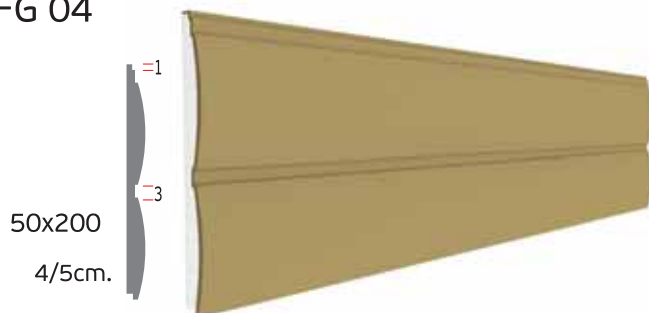

CFG 09

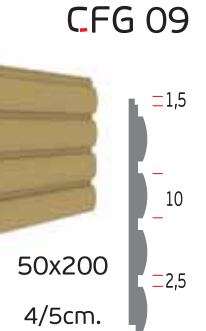

CFG 10

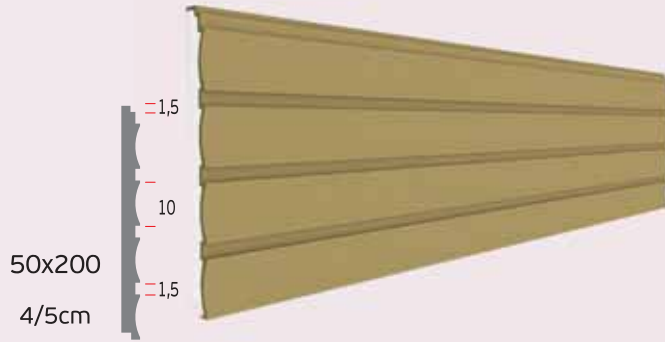

CFG 15

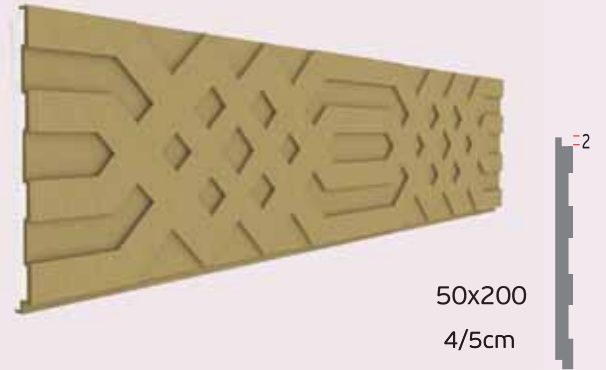

CFG 12



CFG 16

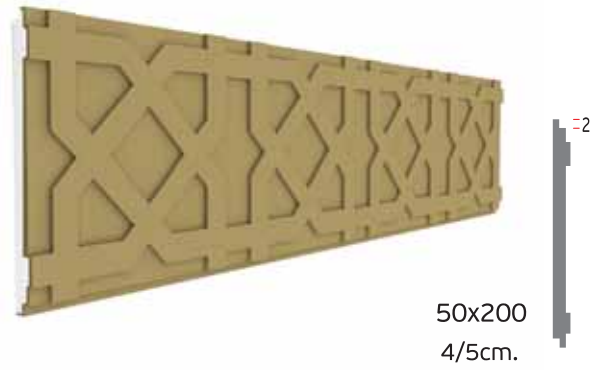

CFG 13

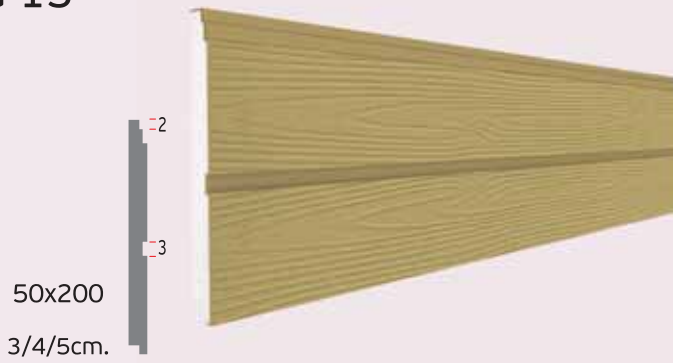

CFG 17

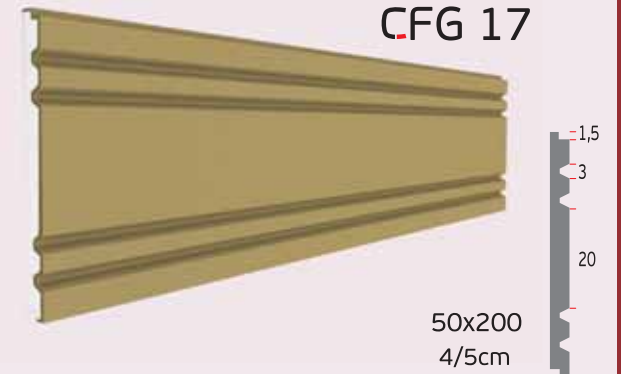

CFG 14

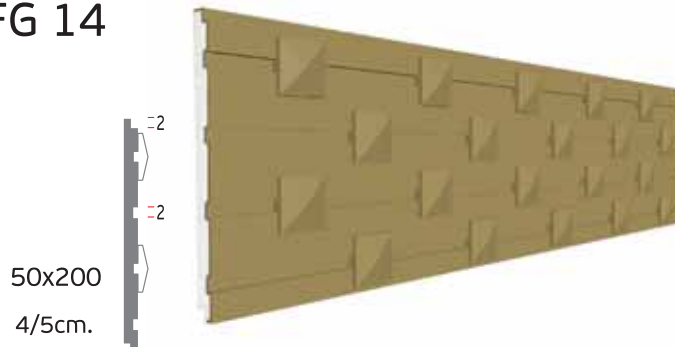

CFG 19



CFG 20

 1,3  
 11  
 50x200  
 3/4/5cm.

CFG 52

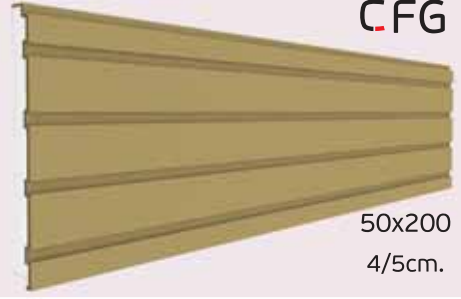
 2  
 50x200  
 4/5cm.

CFG 21 70x200

CFG 23 50x50

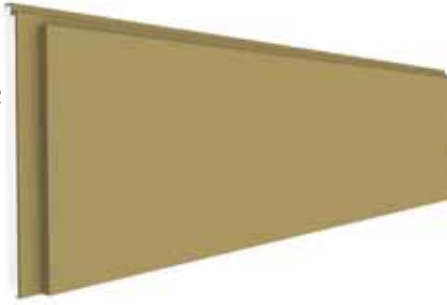
 2  
 4/5cm \*Kompozit görünümlü

CFG 62

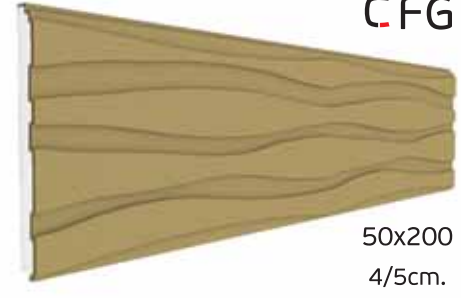
 1,5  
 50x200  
 4/5cm.

CFG 40

 2  
 4  
 50x200  
 3/4/5cm.

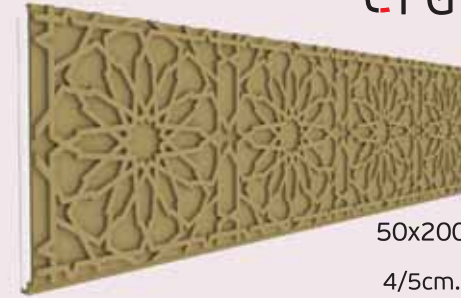

CFG 63

 1,5  
 50x200  
 4/5cm.

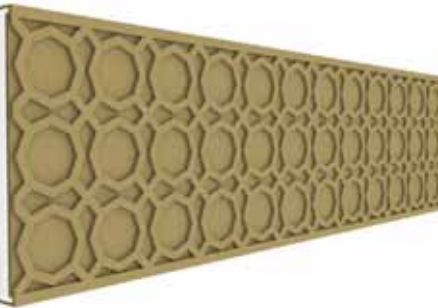
CFG 50

 50x200  
 4/5cm.

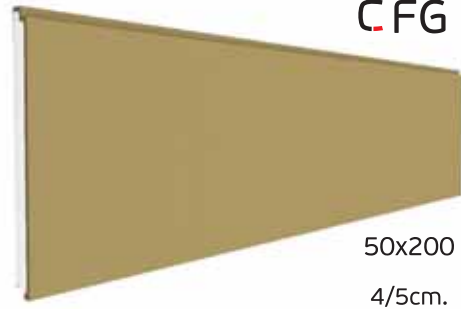
CFG 64

 1  
 50x200  
 4/5cm.

CFG 51

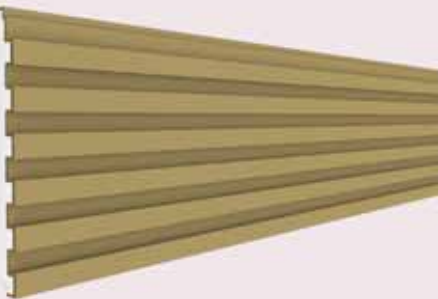
 2  
 4  
 4  
 50x200  
 4/5cm.

CFG 65

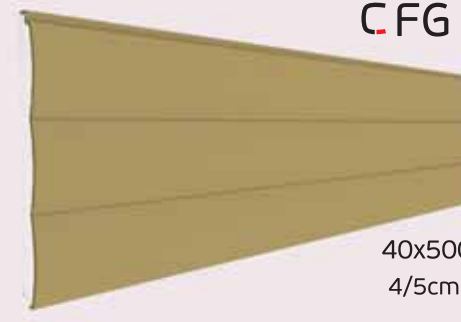
 40x500  
 4/5cm.

CTGK 01

20x200  
4/5cm



CTGK 04

50x200  
4/5cm

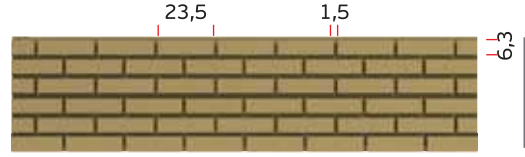

CTGK 02

40x200  
4/5cm

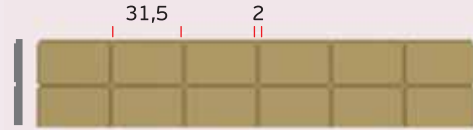

CTGK 07

50x200  
4/5cm

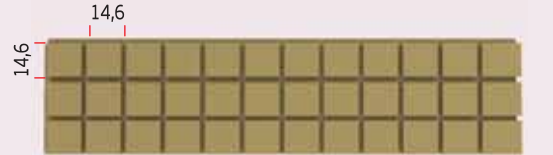

CTGK 03

50x200  
4/5cm

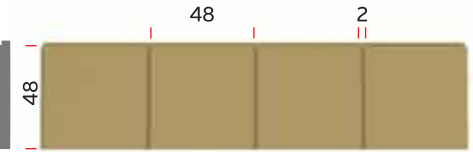

CTGK 09

50x200  
4/5cm



Yalı Baskı

Shore Siding  
تلبیس واجهات

**cukurova**<sup>®</sup>  
polistren dekor

CYB 01

50x200  
4/5cm

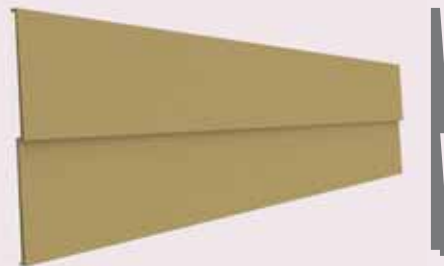

CYB 02

50x200  
3,5/4/5cm



CYB 03

50x200  
3,5/4/5cm



CFG 35  
 120x50x5

 CFG 46  
 130x50x5

 CFG 36  
 120x50x4

 CFG 47  
 120 x50x5

 CFG 37  
 120x60x5

 CFG 59  
 120x50x5

 CFG 38  
 120x60x5

 CFG 60  
 120x50x5

 CFG 39  
 120x50x3,5

 CFG 61  
 120x50x5

 CFG 41  
 130x50x4,5

 CFG 68  
 120x50x5



CYRD 01



5 Kg  
Tamir Harcı  
Repair Mortar  
غراء التصليح

CYRD 01



10 Kg  
Tamir Harcı  
Repair Mortar  
غراء التصليح

CYRD 02



25 Kg  
Yapiştirma Harcı  
Thermal Insulation Board Adhesive  
غراء اللاصق

CYRD 06



Tabanca Temizleyici  
Cleaning Spray  
منظف رشاش

CYRD 05



Poliüretan Yapıştırıcı  
Polyurethane Adhesives  
لاصق البوليوريثين

CYRD 10



İç Cephe  
Ürün Yapıştırıcısı  
Interior Adhesive  
لاصق فلين داخلي

CYRD 07



Tabanca  
Colt  
رشاش

## EPS BEYAZ YALITIM LEVHASI



## EPS KARBONLU YALITIM LEVHASI

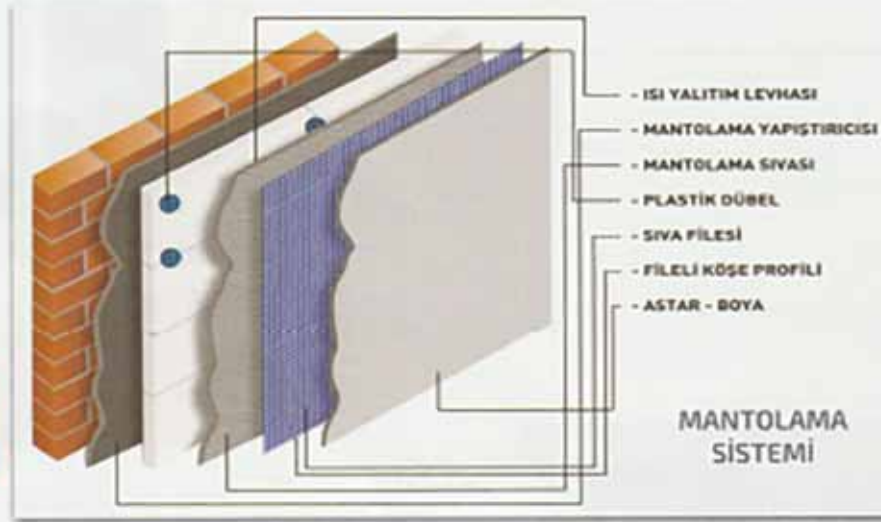

**Güncel Fiyat Alınız!**

MANTOLAMA PAKET ÖLÇÜLERİ	EBAT	POŞET İÇİ ADET	POŞET m <sup>2</sup>	POŞET m <sup>3</sup>	1m <sup>2</sup> kaç m <sup>3</sup>
	3x50x100cm	16 Ad.	8,00 m <sup>2</sup>	0,24m <sup>3</sup>	33,33 m <sup>3</sup>
	4x50x100cm	12 Ad.	6,00 m <sup>2</sup>	0,24m <sup>3</sup>	25 m <sup>3</sup>
	5x50x100cm	10 Ad.	5,00 m <sup>2</sup>	0,25m <sup>3</sup>	20 m <sup>3</sup>
	6x50x100cm	8 Ad.	4,00 m <sup>2</sup>	0,24m <sup>3</sup>	16,67 m <sup>3</sup>
	7x50x100cm	7 Ad.	3,50 m <sup>2</sup>	0,245m <sup>3</sup>	14,29 m <sup>3</sup>

MANTOLAMA PAKET İÇERİĞİ	MALZEMELER	MİKTARLAR
	EPS	50x100
	YAPISTIRMA HARCİ	4,5 kg/m <sup>2</sup>
	SIVA HARCİ	4,5 kg/m <sup>2</sup>
	DEKORATİF SIVA	2,5 kg/m <sup>2</sup>
	SIVA FILESİ	160 gr (1,12 mt/m <sup>2</sup> )
	DÜBEL	10-12 cm (6m <sup>2</sup> /ad)
	KÖŞE PROFİLİ	0,25 mt/m <sup>2</sup>

**CYRD 14**  
Mantolama Dübeli



10 ve 12 cm

**CYRD 11**



Siva Harcı

**CYRD 08**



Dekoratif Siva

**CYRD 16**



Siva Filesi

**CYRD 17**



PVC Fileli  
Köşe Profili



- 145x600x2000 mm
- 170x600x2000 mm
- 125x600x2000 mm

**GÜNCEL  
FİYAT ALINIZ.**

- 520x1020x2020 mm
- 550x1050x2050 mm

SÖVELİK BLOK



KARTONPİYERLİK XPS



**VERİMLİ YUVALARINIZIN  
GÜVENCESİ:**

**CUKUROVA**<sup>®</sup>  
MANTOLAMA







ÖRNEK PENCERE 1



ÖRNEK PENCERE 2



ÖRNEK PENCERE 3



ÖRNEK PENCERE 4



ÖRNEK PENCERE 5



ÖRNEK PENCERE 6



ÖRNEK PENCERE 7



ÖRNEK PENCERE 8



ÖRNEK PENCERE 9



ÖRNEK FRANSIZ PENCERE 1



ÖRNEK FRANSIZ PENCERE 2



ÖRNEK FRANSIZ PENCERE 3



ÖRNEK FRANSIZ PENCERE 4



ÖRNEK FRANSIZ PENCERE 5



ÖRNEK FRANSIZ PENCERE 6



Bitmiş projeler ve benzersiz tasarımlarımızı görmek için web sitemizi ziyaret edebilirsiniz.





## Sertifikalarımız

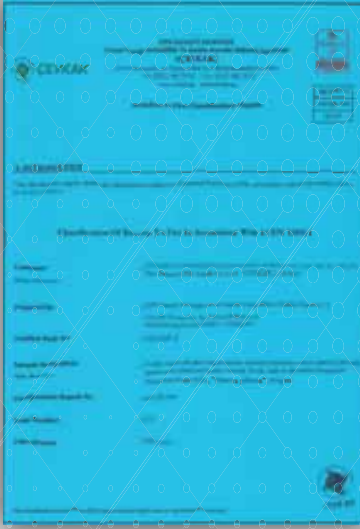

# cukurova®

polistren dekor



+90(322) 428 29 51

+90(322) 428 29 52

info@cukurovapolistren.com

www.cukurovapolistren.com.tr

Acidere O.S.B. Fuzuli Caddesi No:4 Sarıçam / Adana



/cukurovapolistrendekor

Bizi sosyal medya adreslerimizden takip edebilirsiniz.

